

# SUTTNER

A M E R I C A C O M P A N Y

PRESSURE WASHER COMPONENTS & ACCESSORIES

GERMAN ENGINEERED TECHNOLOGY

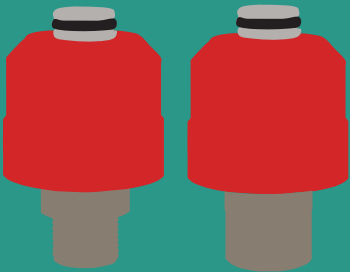
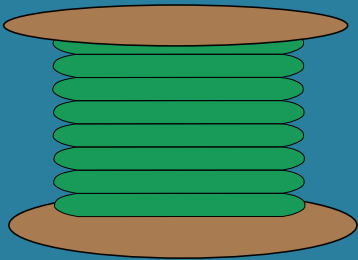
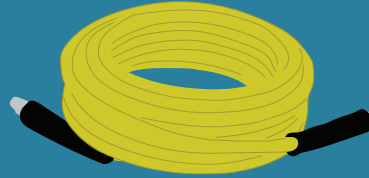
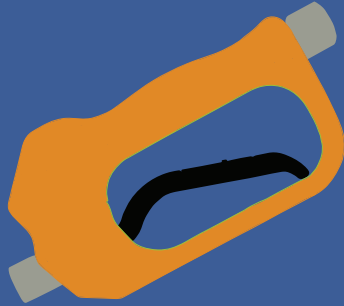

**PRODUCT  
CATALOG  
2025-2026**

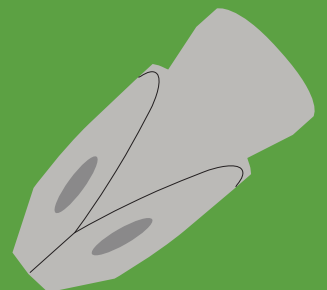
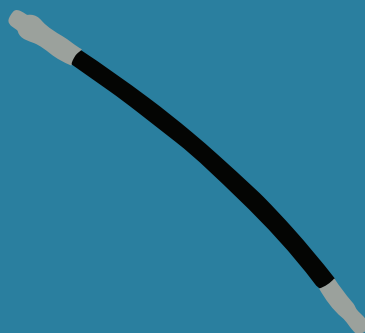

# TABLE OF CONTENTS

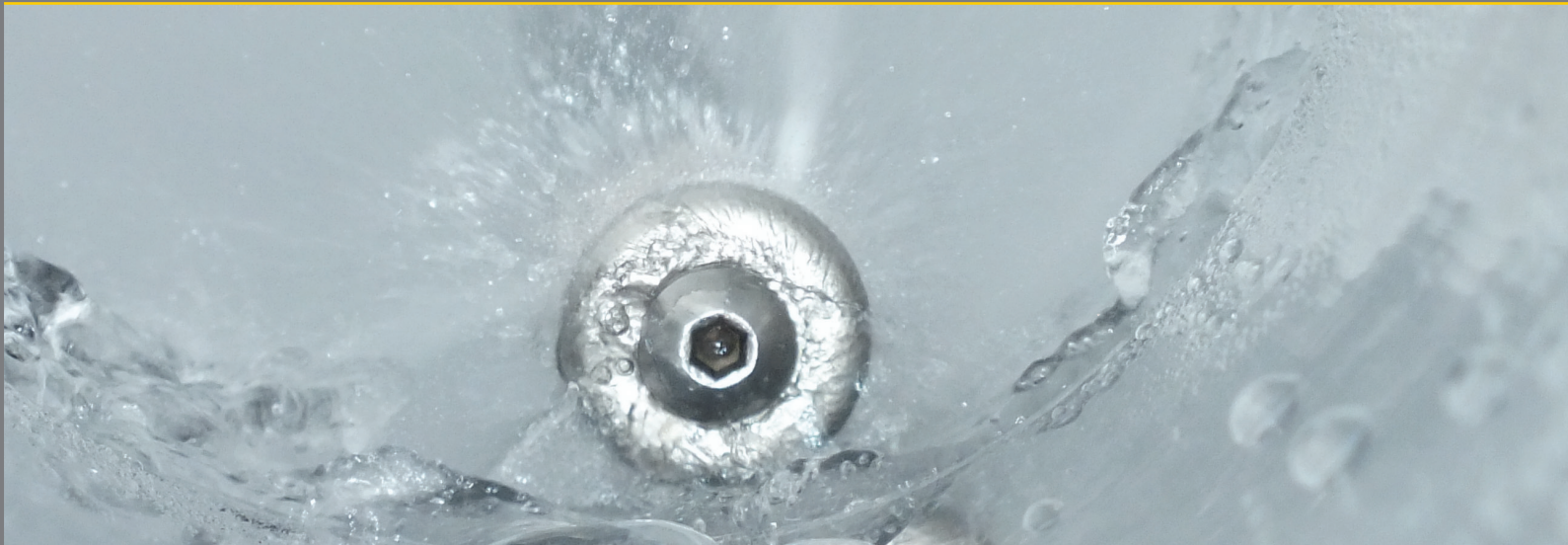

**SPRAY GUNS**.....Pages 8 through 29

**LANCES**.....Pages 30 through 44

**NOZZLES**.....Pages 45 through 73

**HOSES**.....Pages 74 through 90

**FOAMING PRODUCTS**.....Pages 91 through 116

**PRESSURE WASHER ACCESSORIES:**.....Pages 117 through 145

FLOW SWITCHES.....118

PRESSURE SWITCH.....119

UNLOADERS.....120

SOCKETS & PLUGS.....124

SWIVELS.....128

SCREW COUPLERS.....131

SCREW NIPPLES.....132

BREAK AWAY FITTINGS, ADAPTER BUSHING & BAYONETS.....134

VALVES.....135

STRAINERS.....137

CHEMICAL INJECTORS.....138

MISCELLANEOUS ACCESSORIES.....139

## TELESCOPING LANCES



page 42

## 8° TURBO NOZZLE



page 56

## COUNTER TOP PRESSURE WASHER PARTS DISPLAY



page 143

## ST-51.1 VARIABLE SPRAY NOZZLE

page 29 & 59



## HYDRO EXCAVATION SOCKET

page 127



## ST-510 WITH GUARD

page 24



## ST-1700 SPRAY GUN

page 14



## 1/2" FOOT ACTUATED VALVE

page 90



## ST-303 SWIVEL

page 128



## ST-285 1/2" UNLOADER

page 123

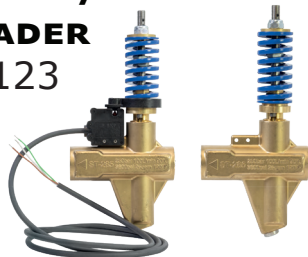

## ST-275 UNLOADER

page 122

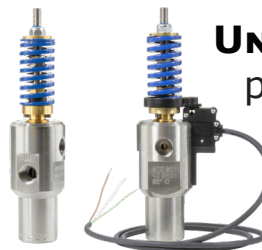

## ST-75.3 FOAM HEAD NOZZLE

page 24



## STAINLESS STEEL DOSING NOZZLES

page 108



## ST-7 FLOW SWITCH

page 119



## STAINLESS STEEL KEW COUPLER

page 29



## ECS JET NOZZLE

page 114



# TERMS & CONDITIONS

## **Payment:**

*Standard terms are net 30 days from date of invoice for accounts with approved credit. A service charge of 1.5% per month may be assessed on invoices over 30 days. In addition, we do accept credit card and ACH payments.*

## **Shipping:**

*F.O.B. Dubuque, IA. All ground orders are shipped exclusively by United Parcel Service (UPS).*

***There is a \$10.00 charge per order for drop shipments. All Drop Ship orders are to ship pre-paid and add. Drop ship invoices are faxed/emailed, providing immediate freight cost information.***

## **Pricing:**

*Suttner America Company reserves the right to change discounts and/or pricing without notice. Trade discounts are based upon unit and dollar volume and are inclusive of warranty allowance. A surcharge may be added to individual orders in response to foreign currency exchange rate fluctuations.*

## **Minimum Order:**

***\$100 minimum is required for all orders. Minimum quantities may apply for some items as noted with an asterisk and/or text.***

## **Returns:**

*Returned goods are subject to a 15% restocking fee. Only goods returned with a Return Goods Authorization Number (RGA#) will be accepted at our warehouse. Obtain an RGA # from Suttner America Company before returning any goods.*

## **Shipping Discrepancies:**

***Discrepancies must be submitted within 24 hours of receipt of goods.***

## **Stocking Orders:**

*Stocking orders can be ordered in multiple shipments; within the time-frame noted. To maintain the stocking order discounts levels; 45% of the minimum annual volume for that discount level must be delivered within that six month period. Suttner America Company reserves the right to periodically review and adjust discount levels based upon actual or estimated annual purchase volume.*

*The preceding use of the term "delivered" distinguishes between product ordered and product shipped. Maintaining a discount is determined by volume of product shipped.*

*Suttner America Company is dedicated to shipping all orders no later than the day specified. It is necessary that Suttner America Company be kept advised of high volume customer needs. Placed orders with scheduled releases assures that product is in-house and ready for just-in-time delivery. Suttner America Company customers do not have to contend with manufacturing lead times or international shipping. Suttner America Company maintains a high volume production run inventory providing customers with cost effective manufacturing and shipping processes.*

*Possession of this catalog or any other Suttner America Company material should not be construed as an offer to sell.*

## **Water Quality:**

*Water should be clean water and have no floating particles (these particles reduce product life). Under no circumstances should your machine be supplied with water from a pond, sea or fully demineralized water. To ensure, you are using clean water, put a sample of water in a glass, let it stand for a few hours and then check to see if any floating particles have settled at the bottom of the glass.*

## **Disclaimer:**

***Product information and specifications are subject to change and Suttner reserves the right to make changes to the catalog at any time without notice. All reasonable efforts have been made to ensure the accuracy of the information.***

# ABOUT US

**For 60 Years:** The SUTTNER brand is recognized for many of the modern innovations in the high pressure cleaning applications today.

- 375 employees world wide.
- 430,000 square foot factory space worldwide.
- Suttner supplies components to more than 75 countries.
- In-house production of 95% of **ALL** products sold.

**Training:** We are committed to training, we believe the more knowledge the customer has, the easier the selling process.

**Innovation:** Suttner strives to develop 2 products each month on average.

**Reliability:** We strive to fill orders in a timely manner.

**Integrity:** Is a concept of consistency of actions, values, methods, measures, principles, expectations and outcomes.

**Consistency:** Our integrity guides us to supply our customers with the parts and accessories in a manner that they request.

**Quality:** Product branded with the SUTTNER name is designed and manufactured with quality products that features comfortable and easy function use that customers have come to expect for over **60 years**.

**Discipline:** Our management team has the business acumen to stay true to business strategies that partner with like-minded customers.

**Loyalty:** A shared business loyalty model combining quality of product and service leads to mutually satisfying and profitable relationships.

**Partnership:** Development of successful, long term, strategic relationships based on achieving best practice and sustainable competitive advantages.

**Knowledge:** Our North American staff average 18 years of industry experience.

**Location:** Central USA warehouse for quick shipping direct to all locations.

*Our management team is driven by a true commitment to customer's needs. The Suttner team has extensive experience and provides the technical support needed. We specialize in personal service, spending time with customers over the phone or in person to diligently understand customer's needs and markets.*



***Visit our Website***



***Like us on Facebook***



***Follow us on Linked In***



***Visit our YouTube Channel to view these videos and many more!***

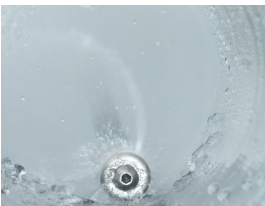
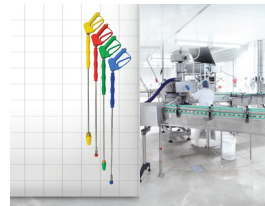

# SPRAY GUNS

PRIVATE LABEL SPRAY GUNS: 9

SPRAY GUN CHART: 10

FRONT ENTRY SPRAY GUNS: 12

REAR ENTRY SPRAY GUNS: 14

INLINE SPRAY GUNS: 22

SOFT WASH DOWN SPRAY GUNS: 24

WEEP SPRAY GUNS: 25

STEAM SPRAY GUNS: 27

SPRAY GUN ASSEMBLIES: 28

SPRAY GUN ACCESSORIES: 29



## GET YOUR COMPANY NOTICED

## PROMOTE YOUR COMPANY NAME OR LOGO WITH A PRIVATE LABEL



*Printed*



*Molded*

### ***Spray Guns:***

- ST-2012, ST-2300 series, ST-2600 series, ST-2700 series, ST-3500, and ST-3600.
- Labels are customized to fit with YOUR company's colors and branding.
- Customizing the color of the shell is also available, excluding ST-3500 and ST-3600.
- Contact us for minimum quantities required.



# SPRAY GUN CHART

									
	<b>ST-601</b>	<b>ST-601C</b>	<b>ST-810</b>	<b>ST-810 P.O.M</b>	<b>1100</b>	<b>ST-1200B</b>	<b>ST-1200S</b>	<b>ST-1500</b>	<b>ST-1500C</b>
Page Number	22	22	12	12	13	24	24	13	13
Pressure Rating	4000 PSI	4000 PSI	3050 PSI	2000 PSI	3050 PSI	350 PSI	350 PSI	5000 PSI	4000 PSI
Gallons Per Minute	12 GPM	12 GPM	8 GPM	12 GPM	7 GPM	27 GPM	27 GPM	10.4 GPM	12 GPM
Temperature Rating	300° F	300° F	320° F	320° F	300° F	190° F	190° F	300° F	302° F
Inlet Size	3/8" FPT	3/8" FPT	3/8" FPT	1/4" & 3/8" FPT	3/8" FPT	1/2" FPT	1/2" FPT	3/8" FPT	3/8" FPT
Outlet Size	1/4" FPT	1/4" FPT	1/4" FPT	1/4" FPT	1/4" FPT	—	—	1/4" FPT	1/4" FPT
Valve Housing	Brass	Brass	Brass	Brass	Brass	Brass	Stainless Steel	Brass	Brass
Stainless Steel Component	✓	✓	✓	✓	—	✓	✓	✓	✓
Chemical Resistant	—	✓	—	✓	—	—	—	—	✓
Easy-Pull Trigger	—	—	—	—	—	—	—	—	—
Relax Action Trigger	—	—	—	—	—	—	—	—	—
Food Grade	—	—	—	—	—	—	✓	—	—
Private Label Availability	—	—	—	—	—	—	—	—	—
Stainless Steel Component	ST-610 Weep	—	ST-810 Weep	—	—	—	—	—	—
Available in Additional Colors	—	—	—	—	—	—	✓	—	—

									
	<b>ST-1500H</b>	<b>ST-1500 S.S.</b>	<b>ST-1700</b>	<b>ST-2000</b>	<b>ST-2012</b>	<b>ST-2305</b>	<b>ST-2305 KEW Coupler</b>	<b>ST-2315</b>	<b>ST-2320</b>
Page Number	13	14	14	14	15	15	16	16	17
Pressure Rating	—	5000 PSI	5000 PSI	5000 PSI	5000 PSI	5000 PSI	5000 PSI	5000 PSI	1800 PSI
Gallons Per Minute	—	10.4 GPM	10.5 GPM	10.4 GPM	10.5 GPM	12 GPM	12 GPM	12 GPM	21 GPM
Temperature Rating	300° F	300° F	300° F	300° F	302° F	300° F	300° F	300° F	300° F
Inlet Size	3/8" FPT	3/8" FPT	3/8" FPT	3/8" FPT	3/8" FPT	3/8" FPT & 3/8" FPT Swivel	3/8" FPT	3/8" FPT	1/2" FPT Swivel
Outlet Size	1/4" FPT	1/4" FPT	1/4" FPT	1/4" FPT	1/4" FPT	1/4" FPT	KEW Q.C Socket	1/4" FPT	1/2" FPT
Valve Housing	Open	Stainless Steel	Brass	Brass	Brass	Brass	Brass	Brass	Brass
Stainless Steel Component	✓	✓	✓	✓	✓	✓	✓	✓	✓
Chemical Resistant	—	—	—	—	—	—	—	✓	✓
Easy-Pull Trigger	—	—	—	—	—	✓	—	✓	—
Relax Action Trigger	—	—	—	—	—	✓	—	✓	—
Food Grade	—	—	—	—	—	—	—	—	✓
Private Label Availability	—	—	—	—	—	✓	✓	✓	—
Stainless Steel Component	—	—	—	—	—	ST-2300 Weep	—	—	—
Available in Additional Colors	—	—	—	—	—	✓	—	—	—

# SPRAY GUN CHART

									
<b>ST-2605</b>	<b>ST-2605F</b>	<b>ST-2620</b>	<b>ST-2620F</b>	<b>ST-2635</b>	<b>ST-2700</b>	<b>ST-2715</b>	<b>ST-2720</b>	<b>ST-2720F</b>	<b>ST-2750</b>
17	17	18	18	19	19	19	20	20	20
5000 PSI	5000 PSI	1800 PSI	4000 PSI	6000 PSI	5000 PSI	5000 PSI	1800 PSI	4000 PSI	7300 PSI
12 GPM	12 GPM	21 GPM	18 GPM	9 GPM	12 GPM	12 GPM	21 GPM	18 GPM	8 GPM
300° F	300° F	300° F	300° F	302° F	300° F	300° F	300° F	300° F	300° F
3/8" FPT	3/8" FPT	3/8" FPT	3/8" FPT	3/8" FPT	3/8" FPT	3/8" FPT	3/8" FPT	3/8" FPT	3/8" FPT
1/4" FPT	1/4" FPT	1/4" FPT	1/4" FPT	1/4" FPT	1/4" FPT	1/4" FPT	1/4" FPT	1/4" FPT	1/4" FPT
Brass	Brass	Brass	Brass	Stainless Steel	Stainless Steel	Stainless Steel	Stainless Steel	Stainless Steel	Stainless Steel
—	—	—	—	✓	✓	✓	✓	✓	✓
—	—	—	—	—	—	✓	✓	✓	—
—	—	—	—	—	—	—	—	—	—
—	—	✓	✓	✓	✓	✓	✓	✓	✓
—	—	—	—	—	—	✓	—	✓	—
✓	✓	✓	✓	✓	✓	✓	✓	✓	✓
—	—	—	—	—	—	—	—	—	—
—	—	—	—	—	✓	—	—	—	—
									
<b>ST-3225</b>	<b>ST-3240</b>	<b>ST-3300</b>	<b>ST-3500</b>	<b>ST-3600</b>	<b>ST-4000</b>	<b>ST-510</b>	<b>ST-860D</b>	<b>SA-3240</b>	
22	23	21	21	21	27	24	27	23	
870 PSI	4500 PSI	2170 PSI	5000 PSI	8700 PSI	290 PSI	362 PSI	290 PSI	3200 PSI	
31.5 GPM	32 GPM	27 GPM	53 GPM	21 GPM	13 GPM	18 GPM	—	16 GPM	
212° F	212° F	300° F	300° F	300° F	392° F	122° F	392° F	300° F	
1/2" FPT	1/2" FPT	1/2" FPT	1/2" FPT Swivel	1/2" & 3/8" FPT	3/4" FPT	1/2" FPT	1/4" FPT	1/2" FPT	
1/2" FPT	1/2" FPT	1/2" FPT	1/2" FPT	1/4" & 1/2" FPT	Steam Nozzle	1/2" FPT	1/4" FPT	1/2" FPT	
Stainless Steel	Stainless Steel	Stainless Steel	Stainless Steel	Stainless Steel	Aluminum	—	Aluminum	Brass	
✓	✓	✓	✓	✓	✓	✓	✓	✓	
✓	✓	✓	—	—	—	✓	✓	—	
—	—	—	—	—	—	—	—	—	
—	—	—	—	—	—	—	—	—	
—	—	✓	—	—	—	—	—	—	
✓	✓	—	✓	✓	—	—	—	—	
—	—	—	—	—	—	—	—	—	
—	—	—	—	—	—	—	—	—	

# SPRAY GUNS: FRONT ENTRY



## **ST-810 SPRAY GUN** (front entry)

*Ideal for car wash, fleet wash and truck wash operations.*

ORDER #	PRESSURE	TEMP.	FLOW RATE	INLET	OUTLET	WEIGHT	BOX QTY
200810510	3050 PSI	320° F	8 GPM	3/8" FPT	1/4" FPT	.82 lb	50

**Repair Kit:** #200810400

- Front inlet design keeps dirty hose just far enough away, keeping the operator clean.
- Most economical light to medium duty spray gun ever.
- Forged brass housing for maximum strength.



## **ST-810 P.O.M. SPRAY GUN** (chemical resistant)

*Perfect chemical application gun with a stainless steel spring, needle, ball and a poly seat for the best chemical resistance.*

ORDER #	PRESSURE	TEMP.	FLOW RATE	INLET	OUTLET	WEIGHT	BOX QTY
200810511	2000 PSI	320° F	8 GPM	3/8" FPT	1/4" FPT	.82 lb	50
200810525	2000 PSI	320° F	8 GPM	1/4" FPT	1/4" FPT	.82 lb	50
200810526	2000 PSI	320° F	8 GPM	1/4" FPT	1/4" FPT	.82 lb	50

**Repair Kit:** #200810492

- Front inlet design keeps dirty hose just far enough away, keeping the operator clean.
- Most economical light to medium duty spray gun ever.
- Forged brass housing for maximum strength.
- **Chemical Resistant.**
- #200810526 has FKM seals

### **LEGEND:**



**EASY PULL TRIGGER:** German Engineered Technology reduces the trigger pulling force by 60% compared to standard spray guns. It is designed for operators and applications with high-volume of trigger cycling.



**FOOD GRADE:** Perfect cleaning tools for the food industry.



**LOW FRICTION TRIGGER:** this gun's trigger system incorporates a ball between the trigger and piston rod contact area that rolls when triggered resulting in a much easier opening and holding.



**PRIVATE LABEL AVAILABILITY:** Promote your company name or logo with customizing select spray guns' label.



**RELAX ACTION:** German Engineered Technology reduces trigger pulling force by 40% and holding force up to 90% compared to standard spray guns. It is designed for operators and applications with longer periods of cleaning time.

# SPRAY GUNS: FRONT ENTRY

## ST-1100 SPRAY GUN *(light weight)*

Perfect for cold water units in factories, plants or smaller hot water units.

ORDER #	PRESSURE	TEMP.	FLOW RATE	INLET	OUTLET	WEIGHT	BOX QTY
201100510	3050 PSI	300° F	7 GPM	3/8" FPT	1/4" FPT	.94 lb	50

Repair Kit: #201100401

- Ergonomically designed spray angle and easy to squeeze, even for small hands.
- Stainless steel spring, needle, ball and seat.
- Forged brass housing for maximum strength.



## ST-1500 SPRAY GUN *(most popular gun)*

Industry standard, the ST-1500 is well-suited for a variety of industrial pressure washing applications.

ORDER #	PRESSURE	TEMP.	FLOW RATE	INLET	OUTLET	WEIGHT	BOX QTY
201500910	5000 PSI	300° F	10.4 GPM	3/8" FPT	1/4" FPT	1.24 lb	50

Repair Kit: #201500496

- Designed to be "universally" comfortable, even for small hands.
- Forged brass housing for maximum strength.
- Unitized valve for easy repair.
- Stainless steel spring, needle, ball and seat.
- Fully rebuild-able, convenient seven screw access to cartridge-type valve assembly makes this gun easy to rebuild and a wise long-term investment.
- LFT (Low Friction Trigger) this gun's trigger system incorporates a ball between the trigger and piston rod contact area that rolls when triggered resulting in a much easier opening and holding.



## ST-1500C SPRAY GUN *(ceramic ball)*

ORDER #	PRESSURE	TEMP.	FLOW RATE	INLET	OUTLET	WEIGHT	BOX QTY
201500572	4000 PSI	302° F	12 GPM	3/8" FPT	1/4" FPT	1.24 lb	50

Repair Kit: #202000054

- Designed from the "industry standard" ST-1500 Spray Gun.
- **Chemical Resistant.**
- Stainless steel inlet and outlet.
- LFT (Low Friction Trigger) this gun's trigger system incorporates a ball between the trigger and piston rod contact area that rolls when triggered resulting in a much easier opening and holding.

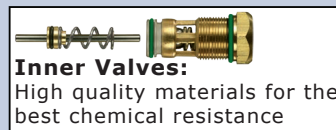

## ST-1500H OPEN SPRAY GUN ST-1500 *(manual start machines)*

Ideal when unloader is unavailable or for manual start pressure washers

ORDER #	TEMP.	INLET	OUTLET	WEIGHT	BOX QTY
201500751	300° F	3/8" FPT	1/4" FPT	.82 lb	50

- Flow through design offers less downtime for repairs.
- Heavy duty molded handle.
- **For lower pressure applications.**



# SPRAY GUNS: REAR ENTRY



LFT

## **ST-1500 STAINLESS STEEL SPRAY GUN**

Industry standard, the ST-1500 is well-suited for a variety of industrial pressure washing applications.

ORDER #	PRESSURE	TEMP.	FLOW RATE	INLET	OUTLET	WEIGHT	BOX QTY
201500911	5000 PSI	300° F	10.4 GPM	3/8" FPT	1/4" FPT	1.24 lb	50

Repair Kit: #201500496

- Industry Standard - well-suited for a variety of industrial pressure washing applications.
- Unitized valve for easy repair.
- Stainless steel spring, needle, ball and seat.
- Stainless steel outlet, inlet connection, including inlet pipe.
- Fully rebuild-able .
- LFT (Low Friction Trigger) this gun's trigger system incorporates a ball between the trigger and piston rod contact area that rolls when triggered resulting in a much easier opening and holding.

NEW!



## **ST-1700 SPRAY GUN (ergonomic design for small hands)**

ORDER #	PRESSURE	TEMP.	FLOW RATE	INLET	OUTLET	WEIGHT	BOX QTY
201700600	5000 PSI	302° F	10.5 GPM	3/8" FPT	1/4" FPT	1.25 lb	—

- Perfect gun for smaller hand operators.
- Comfortable grip and reduces fatigue for longer working hours.
- This unique design reduces wear to a minimum on the internal components.
- Great choice for hot and cold pressure washer use.
- Same inlet & outlet angles as our ST-1500 & ST-2000 spray guns.
- LFT (Low Friction Trigger) this gun's trigger system incorporates a ball between the trigger and piston rod contact area that rolls when triggered resulting in a much easier opening and holding.
- 30% less vibration transfer than standard trigger guns when being used with turbo nozzles, telescopic lances, sand blasters, etc.
- Requires about 13% less squeeze force than a standard trigger gun to open and hold the trigger. In addition, it has less back force while spraying due to the optimum hand position.



LFT

## **ST-2000 SPRAY GUN (extreme duty)**

Our most popular industrial production gun, the ST-2000 is designed for heavy-duty durability. The strongest made gun in it's class takes the abuse.

ORDER #	PRESSURE	TEMP.	FLOW RATE	INLET	OUTLET	WEIGHT	BOX QTY
202000920	5000 PSI	300° F	10.4 GPM	3/8" FPT	1/4" FPT	1.64 lb	35

Repair Kit: #201500496

- Stainless steel spring, needle, ball and seat.
- Forged brass housing for maximum strength.
- Unitized valve for easy repair.
- Suttner's "Big Hand" spray gun.
- LFT (Low Friction Trigger) this gun's trigger system incorporates a ball between the trigger and piston rod contact area that rolls when triggered resulting in a much easier opening and holding.

# SPRAY GUNS: REAR ENTRY

## ST-2012 SPRAY GUN (ergonomic design)

This unique design also reduces wear to a minimum on the internal components.

ORDER #	PRESSURE	TEMP.	FLOW RATE	INLET	OUTLET	WEIGHT	BOX QTY
202012605	5000 PSI	302° F	10.5 GPM	3/8" FPT	1/4" FPT	1.25 lb	40

Repair Kit: #201500496

- Comfortable grip and reduces fatigue for longer working hours.
- This unique design reduces wear to a minimum on the internal components.
- Great choice for hot and cold pressure washer use.
- Same inlet & outlet angles as our ST-1500 & ST-2000 spray guns.
- LFT (Low Friction Trigger) this gun's trigger system incorporates a ball between the trigger and piston rod contact area that rolls when triggered resulting in a much easier opening and holding.
- 30% less vibration transfer than standard trigger guns when being used with turbo nozzles, telescopic lances, sand blasters, etc.
- Requires about 13% less squeeze force than a standard trigger gun to open and hold the trigger. In addition, it has less back force while spraying due to the optimum hand position.



## ST-2305 SPRAY GUNS

Comfort technology designed "Easy-Pull Trigger" and comfortable grip provide ease when working long hours. If you have extreme abuse applications, the ST-2305 is up for the challenge with its handle constructed of impact resistant plastic.

ORDER #	PRESSURE	TEMP.	FLOW RATE	INLET	OUTLET	WEIGHT	BOX QTY
202305600	5000 PSI	300° F	12 GPM	3/8" FPT	1/4" FPT	1.22 lb	50
202305605	5000 PSI	300° F	12 GPM	3/8" FPT	1/4" FPT	1.22 lb	50
202305616	5000 PSI	300° F	12 GPM	3/8" FPT Swivel	1/4" FPT	1.22 lb	50

Repair Kit: #202300490  
Swivel Repair Kit: #200300100

- Easy-Pull is designed for operators and applications with high-volume of trigger cycling.
- Easy-Pull, German Engineered Technology reduces trigger pulling force by 60% compared to standard spray guns.
- Proper spray angle for optimal positioning of pressure points.
- Easiest opening and holding trigger, requires nearly half the effort of the other rear-entry guns.
- Forged brass housing for maximum strength.
- Private Label Availability.

### ALSO AVAILABLE:



#202305660 #202305661 #202305662 #202305663



# SPRAY GUNS: REAR ENTRY



## **ST-2305 Kew Coupler Spray Gun (w/ swivel & coupling)**

Ideal for quick connecting different lances and accessories. Comfort technology designed "Easy Pull Trigger" and comfort grip provide ease when working long hours.

ORDER #	PRESSURE	TEMP.	FLOW RATE	INLET	OUTLET	WEIGHT	BOX QTY
202305650	5000 PSI	300° F	12 GPM	3/8" FPT	KEW Q.C. Socket	1.22 lb	35

Repair Kit: #202300490

- Swivel inlet for hose positioning.
- Proper spray angle for optimal positioning of pressure points.
- Forged brass housing for maximum strength.
- Easy-Pull is designed for operators and applications with high-volume of trigger cycling.
- Easy-Pull, German Engineered Technology reduces trigger pulling force by 60% compared to standard spray guns.
- Private Label Availability.

### **ALSO AVAILABLE:**



#040001258  
Male KEW style plug



#040001255  
Female KEW style plug



## **ST-2315 SPRAY GUN (ceramic ball valve)**

Ceramic ball in valve is highly resistant against nearly all soaps and acids. Comfort technology designed "Easy Pull Trigger" and comfort grip provide ease when working long hours.

ORDER #	PRESSURE	TEMP.	FLOW RATE	INLET	OUTLET	WEIGHT	BOX QTY
202315510	5000 PSI	300° F	12 GPM	3/8" FPT	1/4" FPT	1.30 lb	50

Repair Kit: #202315490

- Easiest opening and holding trigger, requires nearly half the effort of the other rear-entry spray guns.
- Proper spray angle for optimal positioning of pressure points.
- Forged brass housing for maximum strength.
- **Chemical Resistant.**
- Easy-Pull is designed for operators and applications with high-volume of trigger cycling.
- Easy-Pull, German Engineered Technology reduces trigger pulling force by 60% compared to standard spray guns.
- Private Label Availability.

# SPRAY GUNS: REAR ENTRY

## ST-2320 SPRAY GUN (stainless steel swivel)

ORDER #	PRESSURE	TEMP.	FLOW RATE	INLET	OUTLET	WEIGHT	BOX QTY
202320565	1800 PSI	300° F	21 GPM	1/2" FPT Swivel	1/2" FPT	1.70 lb	35

- Comfortable ergonomic hand grip design.
- Easy-Pull is designed for operators and applications with high-volume of trigger cycling.
- Easy-Pull, German Engineered Technology reduces trigger pulling force by 60% compared to standard spray guns.
- Ideal for soft wash systems.
- Great asset for cleaning in food and automotive industries.
- 1/2" F thread swivel inlet and easily attaches to lances or nozzles.
- **Chemical resistant valve piston and seals.**

### ALSO AVAILABLE:



**NEW!**

#200051750  
Spray Nozzle (ST-51.1)  
see page 29



## ST-2605 SPRAY GUN (over center cam)

A commercial cleaner's dream, comfort technology designed trigger system actually helps the operator keep the trigger open. Fatigue is reduced, allowing longer work periods. If you have extreme abuse applications, the ST-2605 is up for the challenge with it's handle constructed of impact plastic.

ORDER #	PRESSURE	TEMP.	FLOW RATE	INLET	OUTLET	WEIGHT	BOX QTY
202605600	5000 PSI	300° F	12 GPM	3/8" FPT	1/4" FPT	1.28 lb	50

Repair Kit: #202300490

- Relax-Action™, German Engineered Technology reduces trigger pulling force by 40% and holding force up to 90% compared to standard spray guns.
- Easiest opening and holding trigger in its class.
- Relax-Action™ is designed for operators and applications with longer periods of cleaning time.
- Forged brass housing for maximum strength.
- Proper spray angle for optimal positioning of pressure points.
- Private Label Availability.



## ST-2605F SPRAY GUN (ideal for foam application)

ORDER #	PRESSURE	TEMP.	FLOW RATE	INLET	OUTLET	WEIGHT	BOX QTY
202605601	5000 PSI	300° F	12 GPM	3/8" FPT	1/4" FPT	1.28 lb	50

Repair Kit: #202300490

- Easiest opening and holding trigger in its class.
- Proper spray angle for optimal positioning of pressure points.
- Orange trigger lock identifies foam spray gun.
- Private Label Availability.
- Relax-Action™, German Engineered Technology reduces trigger pulling force by 40% and holding force up to 90% compared to standard spray guns.
- Relax-Action™ is designed for operators and applications with longer periods of cleaning time.



# SPRAY GUNS: REAR ENTRY



## **ST-2620 SPRAY GUN** (high volume, low pressure)

If you have extreme abuse applications, the ST-2620 is up for the challenge with its handle constructed of impact resistant plastic.

ORDER #	PRESSURE	TEMP.	FLOW RATE	INLET	OUTLET	WEIGHT	BOX QTY
202620510	1800 PSI	300° F	21 GPM	3/8" FPT	1/4" FPT	1.30 lb	50

Repair Kit: #202710490

- Relax-Action™ is designed for operators and applications with longer periods of cleaning time.
- Forged brass housing for maximum strength.
- Proper spray angle for optimal positioning of pressure points.
- Relax-Action™, German Engineered Technology reduces trigger pulling force by 40% and holding force up to 90% compared to standard spray guns.
- Easiest opening and holding trigger in its class.
- Private Label Availability.



## **ST-2620F SPRAY GUN** (high volume)

ORDER #	PRESSURE	TEMP.	FLOW RATE	INLET	OUTLET	WEIGHT	BOX QTY
202620511	4000 PSI	300° F	18 GPM	3/8" FPT	1/4" FPT	1.30 lb	50

Repair Kit: #202710490

- Relax-Action™, German Engineered Technology reduces trigger pulling force by 40% and holding force up to 90%.
- Relax-Action™ is designed for operators and applications with longer periods of cleaning time.
- Proper spray angle for optimal positioning of pressure points.
- Orange trigger lock identifies foam spray gun.
- Private Label Availability.



## **ST-2620F SPRAY GUN w/ FOAM LANCE** (stainless steel)

ORDER #	PRESSURE	TEMP.	FLOW RATE	INLET	WEIGHT
202620915	4000 PSI	300° F	18 GPM	1/2" FPT	2.5 lb

Repair Kit: #202710490

- Relax-Action™ trigger, German Engineered Technology reduces trigger pulling force up to 40% and holding force up to 90%.
- Relax-Action™ is designed for operators and applications with longer periods of cleaning time.
- Forged brass housing for maximum strength.
- Orange trigger lock identifies foam spray gun.
- Ideal for foam application and for injectors using compressed air.
- 50° x 200 mm orifice.

# SPRAY GUNS: REAR ENTRY

## ST-2635 INDUSTRIAL SPRAY GUN (high PSI)

ORDER #	PRESSURE	TEMP.	FLOW RATE	INLET	OUTLET	WEIGHT	BOX QTY
202635600	6000 PSI	302° F	9 GPM	3/8" FPT	1/4" FPT	1.30 lb	50

- Relax-Action™, German Engineered Technology reduces trigger pulling force by 40% and holding force up to 90% compared to standard spray guns.
- Easiest opening and holding trigger in its class.
- Relax-Action™ is designed for operators and applications with longer periods of cleaning time.
- Wear resistant carbide ball.
- Forged brass housing for maximum strength.
- Proper spray angle for optimal positioning of pressure points.
- Private Label Availability.



## ST-2700 SPRAY GUN (stainless steel components)

*Stainless steel components create a durable long lasting trigger gun, especially suitable when using alkaline. Comfort technology designed trigger system actually helps the operator keep the trigger open. Fatigue is reduced, allowing longer work periods.*

ORDER #	PRESSURE	TEMP.	FLOW RATE	INLET	OUTLET	WEIGHT	BOX QTY
202700600	5000 PSI	300° F	12 GPM	3/8" FPT	1/4" FPT	1.24 lb	50

Repair Kit: #202700490

- Relax-Action™, is designed for operators and applications with longer periods of cleaning time.
- 304 Stainless steel housing.
- Relax-Action™, German Engineered Technology reduces trigger pulling force by 40% and holding force up to 90% compared to standard spray guns.
- Easiest opening and holding trigger in its class.
- Private Label Availability.



### ALSO AVAILABLE:



## ST-2715 SPRAY GUN (ceramic ball valve and viton seals)

*A professional gun with Relax-Action™ trigger design. Stainless steel, ceramic ball, chemically resistant valve and acid resistant stainless steel seat. Perfect for industrial cleaning applications.*

ORDER #	PRESSURE	TEMP.	FLOW RATE	INLET	OUTLET	WEIGHT	BOX QTY
202715600	5000 PSI	300° F	12 GPM	3/8" FPT	1/4" FPT	1.25 lb	50

Repair Kit: #202715490

- Relax-Action™ is designed for operators and applications with longer periods of cleaning time.
- Relax-Action™, German Engineered Technology reduces trigger pulling force by 40% and holding force up to 90% compared to standard spray guns.
- Stainless steel housing.
- Stainless steel valve components.
- **Chemical Resistant.**
- Private Label Availability.



# SPRAY GUNS: REAR ENTRY



## **ST-2720 SPRAY GUN (high volume)**

*Stainless steel valve components create a durable long lasting trigger gun, especially suitable when using corrosive chemicals. The comfort technology designed trigger system actually helps the operator keep the trigger open. Fatigue is reduced, allowing longer work periods.*

ORDER #	PRESSURE	TEMP.	FLOW RATE	INLET	OUTLET	WEIGHT	BOX QTY
202720510	1800 PSI	300° F	21 GPM	3/8" FPT	1/4" FPT	1.25 lb	50

Repair Kit: #202710490

- Relax-Action™ is designed for operators and applications with longer periods of cleaning time.
- Proper spray angle for optimal positioning of pressure points.
- The Relax-Action™, German Engineered Technology reduces trigger pulling force by 40% and holding force up to 90% compared to standard spray guns.
- Easiest opening and holding trigger in its class.
- Stainless steel housing and valve components.
- **Chemical Resistant.**
- Private Label Availability.



## **ST-2720F SPRAY GUN**

ORDER #	PRESSURE	TEMP.	FLOW RATE	INLET	OUTLET	WEIGHT	BOX QTY
202720511	4000 PSI	300° F	18 GPM	3/8" FPT	1/4" FPT	1.30 lb	50

Repair Kit: #202710490

- Relax-Action™ is designed for operators and applications with longer periods of cleaning time.
- Professional model with patented technology.
- Orange trigger lock identifies foam spray gun.
- Stainless steel housing and valve components.
- **Chemical Resistant.**
- Private Label Availability.
- **Optimum foam created 130°F or less.**



## **ST-2750 SPRAY GUN (tungsten carbide ball valve)**

*New patented valve kit and tungsten carbide ball with special valve seat. Economical 7300 PSI spray gun with relax action trigger.*

ORDER #	PRESSURE	TEMP.	FLOW RATE	INLET	OUTLET	WEIGHT	BOX QTY
202750510	7300 PSI	300° F	8 GPM	3/8" FPT	1/4" FPT	1.32 lb	50

Repair Kit: #202750495

- Relax-Action™ is designed for operators and applications with longer periods of cleaning time.
- The Relax-Action™, German Engineered Technology reduces trigger pulling force by 40% and holding force up to 90% compared to standard spray guns.
- Stainless steel housing and valve components.
- Private Label Availability.

# SPRAY GUNS: REAR ENTRY

## **ST-3300 SPRAY GUN** (high volume)

Our highest volume rated industrial gun, the ST-3300 is designed for maximum performance and best chemical resistance. An economical solution for high volume industrial applications.

ORDER #	PRESSURE	TEMP.	FLOW RATE	INLET	OUTLET	WEIGHT	BOX QTY
203300600	2170 PSI	300° F	27 GPM	1/2" FPT	1/2" FPT	2.58 lb	10

Repair Kit: #203300490

- Forged stainless steel housing, piston and malleable seat.
- Special heat and chemical resistant seals.
- **Chemical Resistant.**



**FOOD  
GRADE**

## **ST-3500 SPRAY GUN** (high flow)

ORDER #	PRESSURE	TEMP.	FLOW RATE	INLET	OUTLET	WEIGHT	BOX QTY
203500550	5000 PSI	300° F	53 GPM	1/2" Swivel FPT	1/2" FPT	2.58 lb	10

Repair Kit: #203500490

- Stainless steel components.
- Harden stainless steel valve piston.
- Private Label Availability.



**PL**

## **ST-3600 SPRAY GUN** (high pressure, high volume)

Our highest pressure rated industrial spray gun.

ORDER #	PRESSURE	TEMP.	FLOW RATE	INLET	OUTLET	WEIGHT	BOX QTY
203600600	8700 PSI	300° F	21 GPM	1/2" FPT	1/2" FPT	2.58 lb	10
203600610	8700 PSI	300° F	21 GPM	3/8" FPT	1/4" FPT	2.58 lb	10

Repair Kit: #203600490

Without Valve Cone: #203600491

- Forged stainless steel housing, piston and malleable seat.
- Special heat and chemical resistant seals.
- Private Label Availability.



**PL**

# SPRAY GUNS: INLINE



## **ST-601 SPRAY GUN** (inline applications)

Ideal for cleaning vertical and overhead surfaces. Perfect for washing tractors, trailers, siding, windows, eaves, etc. Heavy duty, impact resistant trigger guard has made the ST-601 an industry standard for manufacturers of telescoping wands.

ORDER #	PRESSURE	TEMP.	FLOW RATE	INLET	OUTLET	WEIGHT	BOX QTY
200601610	4000 PSI	300° F	12 GPM	3/8" FPT	1/4" FPT	1.20 lb	50

Repair Kit: #202000044

- Horizontal flow-through design.
- Forged brass housing for maximum strength.
- Unitized valve for easy repair.
- Stainless steel spring, needle, ball and seat.

### **ALSO AVAILABLE:**

**Mounting Bracket, see page 29**



## **ST-601C SPRAY GUN** (ceramic ball)

ORDER #	PRESSURE	TEMP.	FLOW RATE	INLET	OUTLET	WEIGHT	BOX QTY
200601611	4000 PSI	300° F	12 GPM	3/8" FPT	1/4" FPT	1.16 lb	50

Repair Kit: #202000054

- Horizontal flow-through design.
- Forged brass housing for maximum strength.
- Unitized valve allows for higher temps and longer life.
- **Chemical Resistant.**

### **ALSO AVAILABLE:**

**Mounting Bracket, see page 29**



## **ST-3225 INLINE SPRAY GUN**

The ergonomic design of the ST-3225 helps reduce fatigue. Chemical resistant also makes this gun ideal for the food industry.

ORDER #	PRESSURE	TEMP.	FLOW RATE	INLET	OUTLET	WEIGHT	BOX QTY
203225545	870 PSI	212° F	31.5 GPM	1/2" FPT	1/2" FPT	1.64 lb	10



- LTF "Low Trigger Force" reduces pulling force by 40% and holding force by 90%.
- Close trigger design.
- Lightweight.
- **Chemical Resistant.**
- Stainless steel.
- Private Label Availability.
- **Optimum foam created 130°F or less.**

## ST-3240 HYDRO EX INLINE SPRAY GUN

ORDER #	PRESSURE	TEMP.	FLOW RATE	INLET	OUTLET	WEIGHT	BOX QTY
203240510	4500 PSI	212° F	32 GPM	1/2" FPT	1/2" FPT	1.75 lb	2

Seal Repair Kit: #203240480

Repair Kit: #203240490

- Stainless steel industrial grade.
- Comfortable ergonomic hand grip design and reduces fatigue.
- LTF "Low Trigger Force" reduces pulling force by 40% and holding force by 90%.
- **Chemical Resistant.**
- Private Label Availability.

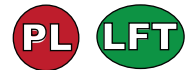

## SA-3240 INLINE HYDRO EXCAVATION SPRAY GUN

ORDER #	PRESSURE	TEMP.	FLOW RATE	INLET	OUTLET	WEIGHT	BOX QTY
403240510	3200 PSI	300° F	16 GPM	1/2" FPT	1/2" FPT	1.85 lb	50

Repair Kit: #403240490

- Impact resistant trigger guard.
- Horizontal flow-through design.
- Safer than a ball valve.



# SPRAY GUNS: SOFT WASH



## ST-510 SOFT WASH SPRAY GUN (low psi)

ORDER #	PRESSURE	TEMP.	FLOW RATE	INLET	OUTLET	WEIGHT	BOX QTY
200510500	362 PSI	122° F	18 GPM	1/2" FPT	1/2" FPT	.3 lb	120

- Designed for low pressure and high flow applications.
- **Chemical Resistant.**
- Ideal for use with soft wash systems.
- Viton (synthetic rubber) seal.
- Rear fluid entry.
- Stainless steel ball and pin.
- Reinforced fibre glass plastic body and seat.
- **Also available with trigger guard.**

NEW!



### ALSO AVAILABLE:

## ST-510 WITH STAINLESS STEEL LANCE

ORDER #	PRESSURE	TEMP.	FLOW RATE	INLET	OUTLET	WEIGHT
200510550	362 PSI	122° F	8 GPM	1/2" FPT	1/2" FPT	.75 lb

- **Chemical Resistant.**
- 24 inches long.



NEW!



## ST-75.3 LOW PRESSURE FOAM HEAD

ORDER #	PRESSURE	TEMP.	INLET	FLOW RATE
200075900	363 PSI	176° F	1/2" M	6.6 GPM

- The foam head itself sucks in air, mixes it with a water-chemical mixture and delivers the resulting foam.
- Adjustable.

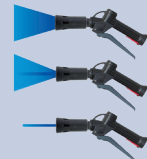

### Additional Accessories Sold Separately



## ST-1200B WASH DOWN GUN (brass)

ORDER #	PRESSURE	TEMP.	FLOW RATE	INLET	WEIGHT	BOX QTY
201200500	350 PSI	122° F	27 GPM	1/2" FPT	1.86 lb	20

- Durable spray gun with rubber sheathing protects against cold, heat and impact.
- Adjusting screw retains desired spray pattern.
- Fixing clamp holds back trigger allowing comfort and steady parts.

FOOD  
GRADE



## ST-1200S WASH DOWN GUN (stainless steel)

ORDER #	PRESSURE	TEMP.	FLOW RATE	INLET	WEIGHT	COLOR	BOX QTY
201200520	350 PSI	190° F	27 GPM	1/2" FPT	1.86 lb	Blue	10
201200521	350 PSI	190° F	27 GPM	1/2" FPT	1.86 lb	Green	10
201200522	350 PSI	190° F	27 GPM	1/2" FPT	1.86 lb	Yellow	10
201200523	350 PSI	190° F	27 GPM	1/2" FPT	1.86 lb	Red	10

- Comes with trigger guard.
- Stainless steel housing.
- Fixing clamp holds back trigger allowing comfort and steady spray.
- Durable spray gun with rubber sheathing protects against cold, heat and impact.
- High volume.
- Adjusting screw retains desired spray pattern.

## **ST-601 WEEP SPRAY GUN** (*inline applications, car wash*)

*Ideal for car washes because of constant weep action to prevent freeze ups. The inline style makes it easier for cleaning vertical and overhead surfaces.*

ORDER #	PRESSURE	TEMP.	FLOW RATE	INLET	OUTLET	WEIGHT	BOX QTY
200601615	4000 PSI	300° F	12 GPM	3/8" FPT	1/4" FPT	1.16 lb	50

**Repair Kit:** #202000046

- Horizontal flow-through design.
- Forged brass housing for maximum strength.
- Unitized valve for easy repair.
- Stainless steel spring, needle, ball and seat.



## **ST-810 WEEP SPRAY GUN** (*front entry*)

*Ideal for car washes, fleet wash and truck wash operations because of constant weep action to prevent freeze ups.*

ORDER #	PRESSURE	TEMP.	FLOW RATE	INLET	OUTLET	WEIGHT	BOX QTY
200810515	3050 PSI	320° F	8 GPM	3/8" FPT	1/4" FPT	.82 lb	50

**Repair Kit:** #200810401

- Front inlet design keeps dirty hose just far enough away, keeping the operator clean.
- Most economical light to medium duty spray gun ever.
- Forged brass housing for maximum strength.



## **ST-1100 WEEP SPRAY GUN** (*light weight, car wash*)

*Ideal for car washes, fleet wash and truck wash operations, because of constant weep action to prevent freeze ups.*

ORDER #	PRESSURE	TEMP.	FLOW RATE	INLET	OUTLET	WEIGHT	BOX QTY
201100525	3050 PSI	300° F	7 GPM	3/8" FPT	1/4" FPT	.94 lb	50

**Repair Kit:** #201100401W

- Ergonomically designed spray angle and easy to squeeze, even for small hands.
- Stainless steel spring, needle, ball and seat.
- Forged brass housing for maximum strength.



# SPRAY GUNS: WEEP



LFT



## ST-1500 WEEP SPRAY GUN

Ideal for car washes, fleet wash and truck wash operations because of constant weep action to prevent freeze ups. The most popular gun for self-service car wash applications.

ORDER #	PRESSURE	TEMP.	FLOW RATE	INLET	OUTLET	WEIGHT	BOX QTY
201500515	4000 PSI	300° F	12 GPM	3/8" FPT	1/4" FPT	1.24 lb	50

Repair Kit: #202000046

- Ideal for car washes, fleet and truck wash operation.
- Forged brass housing for maximum strength.
- LFT (Low Friction Trigger) this gun's trigger system incorporates a ball between the trigger and piston rod contact area that rolls when triggered resulting in a much easier opening and holding.



EP PL

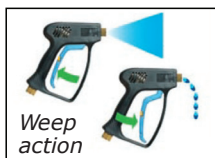

## ST-2300 WEEP SPRAY GUN (car wash)

Ideal for car washes because of constant weep action to prevent freeze ups. Comfort technology designed "Easy-Pull Trigger" and comfortable grip provide ease when working long hours.

ORDER #	PRESSURE	TEMP.	FLOW RATE	INLET	OUTLET	WEIGHT	BOX QTY
202300615	4500 PSI	300° F	12 GPM	3/8" FPT	1/4" FPT	1.24 lb	50

Repair Kit: #202300491

- Easiest opening and holding trigger, requires nearly half the effort of the other rear-entry spray guns.
- Proper spray angle for optimal positioning of pressure points.
- Unitized valve for easy repair.
- Forged brass housing for maximum strength.
- Easy-Pull is designed for operators and applications with high-volume of trigger cycling.
- Easy-Pull, German Engineered Technology reduces trigger pulling force by 60% compared to standard spray guns.
- Private Label Availability.

## **ST-4000 STEAM GUN (true steam)**

Steam is ideal for removing grease and oil, sterilizing surfaces, melting ice, plus using where little water is available like oil fields. Hose connection is positioned in the front of the gun for better handling and keeping the heat away from the operators hand and body.

ORDER #	PRESSURE	TEMP.	LENGTH	FLOW RATE	INLET	OUTLET	WEIGHT	BOX QTY
204000600	290 PSI	392° F	30 in	13 GPM	3/4" FPT	Steam Nozzle	2.25 lb	35

- Designed like regular spray gun with pressure control trigger and with operator safety in mind.
- Stainless steel steam nozzle included. 3/8" M 65° orifice size is #25.0.
- Lightweight.

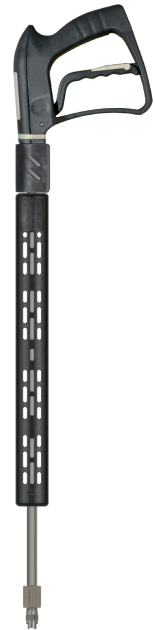

## **ST-860D STEAM GUN (wet steam)**

Made from aluminum and stainless steel, the ST-860D is highly resistant to high temps and chemicals. Hose connection is positioned in the front of the gun for better handling and keeping the heat away from the operators hand and body. Economical version of the ST-4000.

ORDER #	PRESSURE	TEMP.	INLET	OUTLET	WEIGHT	BOX QTY
200860550	290 PSI	392° F	1/4" FPT	1/4" FPT	1.25 lb	25

- Designed with operator safety in mind.
- Lightweight.
- Wet steam application.
- **Chemical Resistant.**



## **ALSO AVAILABLE: ST-860D with Lance**



#200860555



See in action!

[www.youtube.com/watch?v=-y-z7ikKJh8](http://www.youtube.com/watch?v=-y-z7ikKJh8)

# SPRAY GUN: ASSEMBLIES



## **COMPLETE SPRAY GUN / LANCE ASSEMBLY**

Just attach assembly to your pressure washer hose and you are ready to go. Complete assembly includes gun, lance, quick connect socket and plug and 5 spray nozzles.

ORDER #	DESCRIPTION	BOX QTY
Q99950xx1	Gun/Lance Assembly	14

### **XX = Specify Nozzle Size:**

3.0, 3.5, 4.0, 4.5, 5.0, 5.5, 6.0

- The ST-1500 is Suttner's most popular spray gun, rated at 5000 PSI.
- 36" molded grip nickel chrome plated lance with adjustable handle.
- 3/8" M Q.C. plug & 1/4" FPT socket allows quick attachment of nozzle and accessories.
- 5 quick nozzles (0°, 15°, 25°, 40° & soap) in attached nozzle holder.



## **COMPLETE SPRAY GUN / LANCE ASSEMBLY**

Just attach assembly to your pressure washer hose and you are ready to go. Complete assembly includes gun, lance, side handle, quick connect socket and plug and 5 spray nozzles.

ORDER #	DESCRIPTION	BOX QTY
9991500xx	Gun/Lance Assembly	14

### **XX = Specify Nozzle Size:**

3.0, 3.5, 4.0, 4.5, 5.0, 5.5, 6.0

- The ST-1500 is Suttner's most popular spray gun.
- 36" nickel plated lance to resist corrosion.
- 1/4" FPT socket allows quick attachment of nozzle and accessories.
- Adjustable side handle for comfort and control.
- 5 quick connect nozzles.
- Nozzle holder fits 1/4 lance.

# SPRAY GUN: ACCESSORIES

## KEW COUPLINGS

ORDER #	MAX. PRESSURE	TEMP.	MATERIAL
202300350	5000 PSI	300° F	Brass
202700350	6000 PSI	300° F	Stainless Steel

NEW!

- Easily convert any SUTTNER 1/4" trigger gun to the KEW Female Quick Release coupling.
- Requires a 14mm Allen wrench.
- Ideal for quick connecting/releasing lances and accessories.
- Made from durable brass with a thick plastic outer shell.

## ALSO AVAILABLE!

**\*Sold Separately**

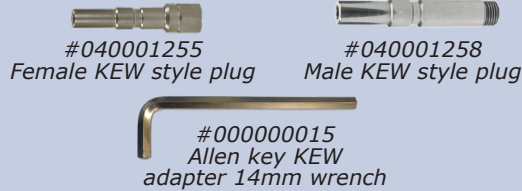

#202300350

NEW!



#202700350



Shown here  
with cover



Shown here on  
spray gun.  
Products sold  
separately.

## SHOULDER SUPPORT

ORDER #	DESCRIPTION
202705590	Fits models: ST-2300, ST-2600 & ST-2700 spray guns

- Helps reduce fatigue when used in high pressure applications.



Shoulder support shown  
here on spray gun.  
Products sold  
separately.

## ST-51.1 VARIABLE SPRAY NOZZLE

ORDER #	PRESSURE	INLET	TEMP.	FLOW RATE	WEIGHT
200051750	900 PSI	1/2" M	190° F	27 GPM	.39 lb

- Adjustable cone sprays from 0° to 90°.
- Stainless steel metal parts and food grade plastic handle.



NEW!



## TELESCOPING LANCE BRACKET KIT

(pre-drilled mounting holes)

ORDER #	DESCRIPTION	MATERIAL
030000720	ST-601 Mounting Plate	Aluminum
020000150	ST-601 Mounting Bracket	Durable Plastic
999000005	Complete Kit (2 plates and bracket)	—



ST-601 shown with mounting  
bracket & telescoping lance

#999000005  
Complete Kit

#030000720

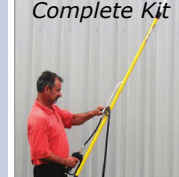

#020000150

# LANCES

**BARE: 31**

**MOLDED GRIP: 32**

**VENTED: 34**

**HYDRO EXCAVATION: 34**

**DUAL: 35**

**TWIN TURBO: 38**

**SPECIALTY: 40**

**LANCE ACCESSORIES: 43**



## \*\*SHIPPING LANCES\*\*

Lances 48 inches and longer will be assessed with an additional handling charge by UPS

### ST-001 LANCES (stainless steel)

ORDER #	PRESSURE	TEMP.	LENGTH	INLET	OUTLET	WEIGHT	BOX QTY
070002008	6000 PSI	300° F	8 in.	1/4" MPT	1/4" MPT	.18 lb	60
070003048	6000 PSI	300° F	12 in.	1/4" MPT	1/4" MPT	.27 lb	50
070004572	6000 PSI	300° F	18 in.	1/4" MPT	1/4" MPT	.40 lb	50
<b>070005001</b>	<b>6000 PSI</b>	<b>300° F</b>	<b>20 in.</b>	<b>1/8" MPT</b>	<b>1/8" MPT</b>	<b>.50 lb</b>	<b>50</b>
070006008	6000 PSI	300° F	24 in.	1/4" MPT	1/4" MPT	.54 lb	50
<b>070009004</b>	<b>7300 PSI</b>	<b>300° F</b>	<b>36 in.</b>	<b>1/4" MPT</b>	<b>1/4" MPT</b>	<b>.80 lb</b>	<b>50</b>
070009008	6000 PSI	300° F	36 in.	1/4" MPT	1/4" MPT	.80 lb	40
070012008	6000 PSI	300° F	47 in.	1/4" MPT	1/4" MPT	1.04 lb	50

- Threads are rolled on providing consistent sealing and four times the strength than cut threads.

• **Chemical Resistant.**

### ST-003 LANCES (nickel chrome plated steel)

Suitable when using corrosive chemicals. Our most popular lances for cold or hot water applications.

ORDER #	PRESSURE	TEMP.	LENGTH	INLET	OUTLET	WEIGHT	BOX QTY
070000025	6000 PSI	300° F	12 in	1/4" MPT	1/4" MPT	.34 lb	100
070000026	6000 PSI	300° F	18 in	1/4" MPT	1/4" MPT	.46 lb	100
070000040	6000 PSI	300° F	24 in	1/4" MPT	1/4" MPT	.64 lb	50
070000055	6000 PSI	300° F	36 in	1/4" MPT	1/4" MPT	.96 lb	50
070000070	6000 PSI	300° F	47 in	1/4" MPT	1/4" MPT	1.28 lb	40
070000080	6000 PSI	300° F	60 in	1/4" MPT	1/4" MPT	1.58 lb	40
070000090	6000 PSI	300° F	79 in	1/4" MPT	1/4" MPT	2.17 lb	40

- Nickel chrome plated steel to prevent rusting.
- Threads are rolled on providing consistent sealing and four times the strength than cut threads.

# LANCES: MOLDED GRIP



## ST-001 LANCE (stainless steel) w/ ST-2 LANCE INSULATOR

Insulator adjusts anywhere on lance for desired ergonomic position and can be removed.

ORDER #	PRESSURE	TEMP.	LENGTH	INLET	OUTLET	WEIGHT	BOX QTY
999072510	6000 PSI	300° F	36 in.	1/4" MPT	1/4" MPT	1.10 lb	25

- Threads are rolled on providing consistent sealing and four times the strength than cut threads.
- **Chemical Resistant.**



#070012002  
7300 PSI

## ST-002 MOLDED GRIP LANCES (stainless steel)

ORDER #	PRESSURE	TEMP.	LENGTH	INLET	OUTLET	WEIGHT	BOX QTY
070009009	6000 PSI	300° F	36 in.	1/4" MPT	1/4" MPT	1.10 lb	20
<b>070012002</b>	<b>7300 PSI</b>	<b>300° F</b>	<b>47 in.</b>	<b>1/4" MPT</b>	<b>1/4" MPT</b>	<b>1.88 lb</b>	20
070012009	6000 PSI	300° F	47 in.	1/4" MPT	1/4" MPT	1.58 lb	20

- Comfort technology designed molded grip conforms to the curvature of the hand, allowing to comfortably change positions.
- Linear aeration provides continuous air flow between hand and exclusive Suttner "star shaped" grip.
- Grip is directly molded on the lance providing protection and strength.
- Favorite molded grip lance design in the industry.
- Threads are rolled on providing consistent sealing and four times the strength than cut threads.
- **Chemical Resistant.**



#079600470  
(comes with side handle)



#070000260 1/8" female outlet ideal for car washes

## ST-007 MOLDED GRIP LANCES (nickel chrome plated steel)

Our most popular lances for cold or hot water applications

ORDER #	PRESSURE	TEMP.	LENGTH	INLET	OUTLET	WEIGHT	BOX QTY
070000330	6000 PSI	300° F	12 in	1/4" MPT	1/4" MPT	.65 lb	40
070000240	6000 PSI	300° F	18 in	1/4" MPT	1/4" MPT	.90 lb	40
<b>070000260</b>	<b>6000 PSI</b>	<b>300° F</b>	<b>18 in</b>	<b>1/4" MPT</b>	<b>1/8" FPT</b>	<b>.88 lb</b>	<b>40</b>
070000180	6000 PSI	300° F	24 in	1/4" MPT	1/4" MPT	.95 lb	30
070000470	6000 PSI	300° F	36 in	1/4" MPT	1/4" MPT	1.28 lb	30
070000210	6000 PSI	300° F	47 in	1/4" MPT	1/4" MPT	1.84 lb	20
070000220	6000 PSI	300° F	60 in	1/4" MPT	1/4" MPT	2.14 lb	20
070000230	6000 PSI	300° F	79 in	1/4" MPT	1/4" MPT	2.70 lb	20
079600470	6000 PSI	300° F	36 in	1/4" MPT	1/4" MPT	1.60 lb	—

- Comfort technology designed molded grip conforms to the curvature of the hand, allowing to comfortably change positions.
- Linear aeration provides continuous air flow between hand and exclusive Suttner "star shaped" grip.
- Grip is directly molded on the lance providing protection and strength.
- Threads are rolled on providing consistent sealing and four times the strength than cut threads.

## ST-29 MOLDED GRIP LANCES *(stainless steel)*

ORDER #	PRESSURE	TEMP.	LENGTH	INLET	OUTLET	WEIGHT	COLOR
200029315	6000 PSI	300° F	36 in.	1/4" MPT	1/4" MPT	1.10 lb.	Blue
200029316	6000 PSI	300° F	36 in.	1/4" MPT	1/4" MPT	1.10 lb.	Yellow
200029317	6000 PSI	300° F	36 in.	1/4" MPT	1/4" MPT	1.10 lb.	Green
200029318	6000 PSI	300° F	36 in.	1/4" MPT	1/4" MPT	1.10 lb.	Red

- Comfortable grip.
- Ergonomic shape.
- Heat-proof insulation.
- **Chemical Resistant.**

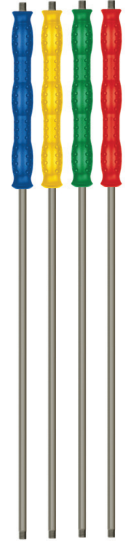

## ST-129 MOLDED GRIP LANCES *(stainless steel)*

ORDER #	PRESSURE	TEMP.	LENGTH	INLET	OUTLET	WEIGHT
200129140	5800 PSI	302° F	20 in.	1/4" MPT	1/4" FPT	.9 lb
200129145	5800 PSI	302° F	28 in.	1/4" MPT	1/4" FPT	1.25 lb

- Threads are rolled on providing consistent sealing and four times the strength than cut threads.
- Female outlet.
- 300 MM insulation.
- Grip is directly molded on the lance providing protection and strength.
- Ergonomic shape.
- **Chemical Resistant.**



# LANCES: VENTED & HYDRO EXCAVATION

24" & 36"



47" - 79"  
(comes with 2  
vented grips)

## **ST-009L VENTED GRIP LANCES** (nickel chrome plated steel)

Suitable when using corrosive chemicals. Our most popular lances for cold or hot water applications.

ORDER #	PRESSURE	TEMP.	LENGTH	INLET	OUTLET	WEIGHT	BOX QTY
200009506	6000 PSI	300° F	24 in	1/4" MPT	1/4" MPT	1.08 lb	10
200009509	6000 PSI	300° F	36 in	1/4" MPT	1/4" MPT	1.46 lb	10
200009512	6000 PSI	300° F	47 in	1/4" MPT	1/4" MPT	2.20 lb	10
200009515	6000 PSI	300° F	60 in	1/4" MPT	1/4" MPT	2.42 lb	10
200009519	6000 PSI	300° F	79 in	1/4" MPT	1/4" MPT	2.94 lb	10

- Vented grip easily adjusts anywhere on lance for anyone's desired ergonomic position.
- Comes with ST-004 nozzle protector (page 51).
- Vented grip allows heat to dissipate providing a cooler handle.
- Threads are rolled on providing consistent sealing and four times the strength than cut threads.

## **1/2" HYDRO EXCAVATION LANCES**

Aluminum



Nickel  
Plated  
Steel

Box Quantity 20

### **Aluminum Sch. 80**

ORDER #	PRESSURE	TEMP.	LENGTH	INLET	OUTLET	WEIGHT
071220003	4000 PSI	300° F	36 in	1/2" MPT	1/2" MPT	0.90 lb
071220004	4000 PSI	300° F	48 in	1/2" MPT	1/2" MPT	1.25 lb
071220005	4000 PSI	300° F	60 in	1/2" MPT	1/2" MPT	1.55 lb
071220006	4000 PSI	300° F	72 in	1/2" MPT	1/2" MPT	1.90 lb

### **Nickel Plated Steel Sch. 40**

ORDER #	PRESSURE	TEMP.	LENGTH	INLET	OUTLET	WEIGHT
071210003	4000 PSI	300° F	36 in	1/2" MPT	1/2" MPT	2.80 lb
071210004	4000 PSI	300° F	48 in	1/2" MPT	1/2" MPT	3.75 lb
071210005	4000 PSI	300° F	60 in	1/2" MPT	1/2" MPT	4.70 lb
071210006	4000 PSI	300° F	72 in	1/2" MPT	1/2" MPT	5.65 lb

### **ALSO AVAILABLE:**

**1/2" LANCE SIDE HANDLE** (for 1/2" hydro excavation lances)



#200009605



Side handle shown here on lance.  
Products sold separately.

## ST-53 DUAL LANCES (plated steel)

For use when high and low pressures are needed. For example, spraying cleaning agents with low pressure through an injector valve and then cleaning with high pressure.

ORDER #	LENGTH	PRESSURE OUTLET	NOZZLE	WEIGHT
200053500	38 in	1/4" F x 1/4" Soap	65° x 30.0	2.10 lb
200053565	72 in	1/4" F x 1/4" Soap	65° x 30.0	4.15 lb

PRESSURE	TEMP.	INLET	BOX QTY
3625 PSI	300° F	1/4" MPT	30

Repair Kits: Knob Assembly #120000005  
Complete Valve Kit #120000010

- High or low pressure operation is controlled by twisting the valve knob.
- Threads are rolled on providing consistent sealing and four times the strength than cut threads.

**\*\*NOTE:** No bend in the 72 inch dual lance.



## ST-53.2 DUAL LANCES (stainless steel)

Perfect for all heavy industrial high pressure spray application.

ORDER #	LENGTH	PRESSURE OUTLET	NOZZLE	WEIGHT
517053600	38.5 in	1/4" F x 1/4" Soap	65° x 30.0	2.75 lb

PRESSURE	TEMP.	INLET	BOX QTY
5800 PSI	302° F	1/4" MPT	12

Repair Kits: Complete Valve Kit #710053492

- For the serious high pressure spray contractors choice.
- Features our comfortable ergonomic shaped cool & compact molded grip resistant to heat.
- **Chemical Resistant.**
- Stainless steel soap nozzle included.
- Easy Hi/Low pressure adjustment handling.
- Premium dual-purpose lance that adds extreme versatility to your tools and accessories.

Simple Hi/low Pressure adjustment valve



All stainless steel valve

# LANCES: DUAL



#200054531  
(nozzle protector  
not included)

## ST-54 DUAL LANCES (plated steel)

For use when high and low pressures are needed. For example, spraying cleaning agents with low pressure through an injector valve and then cleaning with high pressure.

ORDER #	LENGTH	PRESSURE OUTLET	NOZZLE	WEIGHT
200054500	38 in	1/4" F x 1/4" Soap	65° x 30.0	2.72 lb
<b>200054501</b>	<b>38 in</b>	<b>1/4" F x 1/4" Soap</b>	<b>65° x 40.0</b>	<b>2.72 lb</b>
200054530	47 in	1/4" F x 1/4" Soap	65° x 30.0	3.40 lb
<b>200054531</b>	<b>47 in</b>	<b>1/4" F x 1/4" Soap</b>	<b>40° x 40.0</b>	<b>3.40 lb</b>
200054565	72 in	1/4" F x 1/4" Soap	65° x 30.0	5.50 lb

PRESSURE	TEMP.	INLET	BOX QTY
4500 PSI	300° F	1/4" MPT	12

**Repair Kits:** Handle Assembly #200054450  
Complete Valve Kit #200054492

- High or low pressure operation is controlled by twisting the side of the handle.
- The side handle helps manage the lance with ease for longer working periods.
- Threads are rolled on providing consistent sealing and four times the strength than cut threads.
- Soap nozzle included.

**\*\*NOTE:** No bend in the 72 inch dual lance.

## ST-54.2 DUAL LANCE (stainless steel)

Perfect for all heavy industrial high pressure spray application

ORDER #	LENGTH	PRESSURE OUTLET	NOZZLE	WEIGHT
517054600	38.5 in	1/4" F x 1/4" Soap	65° x 30.0	3.20 lb

PRESSURE	TEMP.	INLET	BOX QTY
5800 PSI	302° F	1/4" MPT	12

**Repair Kit:** Complete Valve Kit #710054492



Ergonomic side  
handle for safe  
and simple  
handling

All stainless  
steel valve

- For the serious high pressure spray contractors choice.
- Features our comfortable ergonomic shaped cool & compact molded grip resistant to heat.
- **Chemical Resistant.**
- Stainless steel soap nozzle included.
- Easy Hi/Low pressure adjustment handling.
- Premium dual-purpose lance that adds extreme versatility to your tools and accessories.

## **ST-154 DUAL LANCES** (high psi, stainless steel)

The side handle grip makes an effortless adjustment of the water jet during operation possible. A long casting point jet or a progressive cone like spray jet can be set.

ORDER #	LENGTH	PRESSURE OUTLET	NOZZLE	WEIGHT
200154500	38 in	1/4" F x 1/4" Soap	65° x 30.0	2.62 lb
200154550	50 in	1/4" F x 1/4" Soap	65° x 30.0	3.46 lb

PRESSURE	TEMP.	INLET
7250 PSI	300° F	1/4" MPT

**Repair Kits:** Handle Assembly #200154400  
Complete Valve Kit #200154490

- High or low pressure operation is controlled by twisting the side handle.
- Side handle helps manage the lance with ease for longer working periods.
- Lance is equipped with a 65° x 30.0 brass soap nozzle.
- Threads are rolled on providing consistent sealing and four times the strength than cut threads.

## 7250 PSI



# LANCES: TWIN TURBO

## 3625 PSI



\* Lances  
not sold  
separately



See in action!

<https://www.youtube.com/watch?v=jhj6jGeRUBw>

## ST-357 TWIN TURBO NOZZLE LANCES

The increased tearing action of the rotating spray is ideal for hard surface applications, such as concrete graffiti cleaning or caked mud on heavy equipment.

ORDER #	PRESSURE	TEMP.	LENGTH	INLET	ORIFICE	WEIGHT	NOZZLE REPAIR KIT
999357530	3625 PSI	190° F	42 in	1/4" MPT	2 x 3.0	2.68 lb	200357130
999357535	3625 PSI	190° F	42 in	1/4" MPT	2 x 3.5	2.68 lb	200357135
999357540	3625 PSI	190° F	42 in	1/4" MPT	2 x 4.0	2.68 lb	200357140
999357545	3625 PSI	190° F	42 in	1/4" MPT	2 x 4.5	2.68 lb	200357145
999357550	3625 PSI	190° F	42 in	1/4" MPT	2 x 5.0	2.68 lb	200357150
999357555	3625 PSI	190° F	42 in	1/4" MPT	2 x 5.5	2.68 lb	200357155
999357560	3625 PSI	190° F	42 in	1/4" MPT	2 x 6.0	2.68 lb	200357160
999357570	3625 PSI	190° F	42 in	1/4" MPT	2 x 7.0	2.68 lb	200357170
999357580	3625 PSI	190° F	42 in	1/4" MPT	2 x 8.0	2.68 lb	200357180
999357590	3625 PSI	190° F	42 in	1/4" MPT	2 x 9.0	2.68 lb	200357190
999357510	3625 PSI	190° F	42 in	1/4" MPT	2 x 10.0	2.68 lb	200357110

- Increases cleaning efficiency by as much as 375%.
- The 0° rotation creates a cleaning and tearing action.
- The two turbo nozzles cover twice the amount of surface are resulting in saving time and money.

## 5070 PSI



\* Lances  
not sold  
separately

## ST-456 TWIN TURBO NOZZLE LANCES

The increased tearing action of the rotating spray is ideal for hard surface applications, such as concrete graffiti cleaning or caked mud on heavy equipment.

ORDER #	PRESSURE	TEMP.	LENGTH	INLET	ORIFICE	WEIGHT	NOZZLE REPAIR KIT
999456530	5070 PSI	200° F	42 in	1/4" MPT	2 x 3.0	3.2 lb	200456130
999456535	5070 PSI	200° F	42 in	1/4" MPT	2 x 3.5	3.2 lb	200456135
999456540	5070 PSI	200° F	42 in	1/4" MPT	2 x 4.0	3.2 lb	200456140
999456545	5070 PSI	200° F	42 in	1/4" MPT	2 x 4.5	3.2 lb	200456145
999456550	5070 PSI	200° F	42 in	1/4" MPT	2 x 5.0	3.2 lb	200456150
999456555	5070 PSI	200° F	42 in	1/4" MPT	2 x 5.5	3.2 lb	200456155
999456560	5070 PSI	200° F	42 in	1/4" MPT	2 x 6.0	3.2 lb	200456160
999456570	5070 PSI	200° F	42 in	1/4" MPT	2 x 7.0	3.2 lb	200456170
999456580	5070 PSI	200° F	42 in	1/4" MPT	2 x 8.0	3.2 lb	200456180

- Increases cleaning efficiency by as much as 375%.
- The 0° rotation creates a cleaning and tearing action.
- The two turbo nozzles cover twice the amount of surface are resulting in saving time and money.

# LANCES: TWIN TURBO

## ST-457 TWIN TURBO NOZZLE LANCES

The increased tearing action of the rotating spray is ideal for hard surface applications, such as concrete graffiti cleaning or caked mud on heavy equipment.

ORDER #	PRESSURE	TEMP.	LENGTH	INLET	ORIFICE	WEIGHT	NOZZLE REPAIR KIT
999457530	6000 PSI	212° F	42 in	1/4" MPT	2 x 3.0	4.28 lb	200457130
999457535	6000 PSI	212° F	42 in	1/4" MPT	2 x 3.5	4.28 lb	200457135
999457540	6000 PSI	212° F	42 in	1/4" MPT	2 x 4.0	4.28 lb	200457140
999457545	6000 PSI	212° F	42 in	1/4" MPT	2 x 4.5	4.28 lb	200457145
999457550	6000 PSI	212° F	42 in	1/4" MPT	2 x 5.0	4.28 lb	200457150
999457555	6000 PSI	212° F	42 in	1/4" MPT	2 x 5.5	4.28 lb	200457155
999457560	6000 PSI	212° F	42 in	1/4" MPT	2 x 6.0	4.28 lb	200457160
999457570	6000 PSI	212° F	42 in	1/4" MPT	2 x 7.0	4.28 lb	200457170
999457580	6000 PSI	212° F	42 in	1/4" MPT	2 x 8.0	4.28 lb	200457180
999457590	6000 PSI	212° F	42 in	1/4" MPT	2 x 9.0	4.28 lb	200457190
999457510	6000 PSI	212° F	42 in	1/4" MPT	2 x 10.0	4.28 lb	200457110

- Increases cleaning efficiency by as much as 375%.
- The 0° rotation creates a cleaning and tearing action.
- The two turbo nozzles cover twice the amount of surface are resulting in saving time and money.



**6000 PSI**



**\* Lances not sold separately**

# LANCES: SPECIALTY

**8700 PSI**



#203600402

## ST-3600 LANCES (stainless steel)

This **8700 PSI** rated stainless steel lance is the perfect fit for the ST-3600 spray gun. The stainless steel construction is ideal for chemical applications.

ORDER #	PRESSURE	TEMP.	LENGTH	INLET	OUTLET	WEIGHT
203600400	8700 PSI	300° F	19 in	1/2" MPT	1/4" FPT	2.35 lb
203600402	8700 PSI	300° F	39 in	1/2" MPT	1/4" FPT	3.00 lb
203600450	8700 PSI	300° F	19 in	1/2" MNPT	1/4" FNPT	2.35 lb
203600452	8700 PSI	300° F	39 in	1/2" MNPT	1/4" FNPT	3.00 lb

- Threads are rolled on providing consistent sealing and four times the strength than cut threads.
- Adjustable handle.
- **Chemical resistant.**

## FLEX WANDS

Popular car wash choice and for hard to reach applications.



ORDER #	PRESSURE	TEMP.	OUTLET	COLOR
900000080	2500 PSI	200° F	1/4" MPT x 1/8" FPT	Black
900000081	2500 PSI	200° F	1/4" MPT x 1/4" MPT	Blue

INLET	LENGTH	WEIGHT
1/4" MPT	18 in	.89 lb

- Flexes 180° and returns if pulled or driven over.
- Prevents broken lances.
- Easily fits gun tube in car wash bays.
- Threads are rolled on providing consistent sealing and four times the strength then cut threads.

## ST-85 PUSH/PULL LANCES (for hard to reach areas)

Hard to reach applications, such as gutters, underneath fender walls, truck bellies and heavy equipment. Lance angles from 20° to 90°.



20° angle to 90° angle

ORDER #	PRESSURE	TEMP.	LENGTH	INLET	OUTLET	WEIGHT
200085710 (no handle)	3050 PSI	300° F	33 in	1/4" FPT	1/4" FPT	2.22 lb
200085712 (with handle)	3050 PSI	300° F	33 in	1/4" FPT	1/4" FPT	2.42 lb

- Side handle can be mounted on the left or right side of the lance.
- Great for hard to reach applications such as gutters, decks, underneath fender walls, truck bellies and heavy equipment.
- Cleans hard to reach areas easier; saving time and money.
- Vented grip can be adjusted to make the lance angle from 20° up to 90°.



<https://youtu.be/Kb3ewiUK2Vk>

## ST-78 STAINLESS STEEL LONGCAST LANCES

Works great for cleaning heavy mud equipment.

ORDER #	PRESSURE	ORIFICE	FLOW RATE	INLET
200078540	4000 PSI	—	12 GPM	3/8" F
200078540412	4000 PSI	3.5	12 GPM	3/8" F
200078540415	4000 PSI	5.5	12 GPM	3/8" F
200078540418	4000 PSI	8.0	12 GPM	3/8" F
200078540420	4000 PSI	9.5	12 GPM	3/8" F
200078540423	4000 PSI	10.0	12 GPM	3/8" F
200078540425	4000 PSI	15.0	12 GPM	3/8" F
200078540430	4000 PSI	25.0	12 GPM	3/8" F
200078540435	4000 PSI	30.0	12 GPM	3/8" F
200078540440	4000 PSI	40.0	12 GPM	3/8" F
200078540445	4000 PSI	55.0	12 GPM	3/8" F
200078540450	4000 PSI	60.0	12 GPM	3/8" F
200078540470	4000 PSI	85.0	12 GPM	3/8" F
200078550	2600 PSI	—	21 GPM	1/2" F
200078550412	2600 PSI	3.5	21 GPM	1/2" F
200078550415	2600 PSI	5.5	21 GPM	1/2" F
200078550418	2600 PSI	8.0	21 GPM	1/2" F
200078550420	2600 PSI	9.5	21 GPM	1/2" F
200078550423	2600 PSI	10.0	21 GPM	1/2" F
200078550425	2600 PSI	15.0	21 GPM	1/2" F
200078550430	2600 PSI	25.0	21 GPM	1/2" F
200078550435	2600 PSI	30.0	21 GPM	1/2" F
200078550440	2600 PSI	40.0	21 GPM	1/2" F
200078550445	2600 PSI	55.0	21 GPM	1/2" F
200078550450	2600 PSI	60.0	21 GPM	1/2" F
200078550470	2600 PSI	85.0	21 GPM	1/2" F

TEMP.	LENGTH	WEIGHT
300° F	38 in.	5.40 lb

**Repair Kits:** Handle Kit #200078301  
Piston Kit #200078300

- The side handle grip makes an effortless adjustment of the water jet during operation possible.
- Valve construction all stainless steel.
- Easily change from full jet to conical spray jet spraying.
- Works well with low and high pressure pumps.
- Vented grip lance.

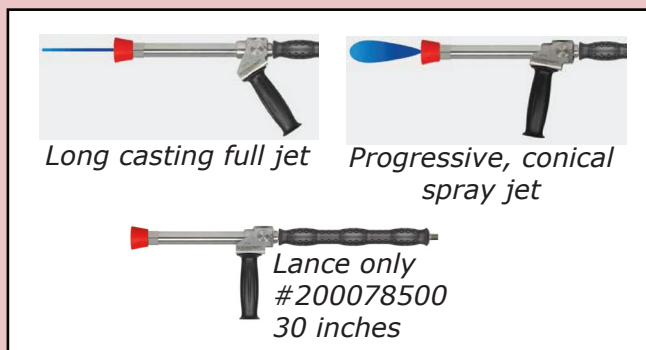

[https://www.youtube.com/watch?v=phLF4Z00YSk&feature=emb\\_logo](https://www.youtube.com/watch?v=phLF4Z00YSk&feature=emb_logo)

# LANCES: SPECIALTY

**NEW!**



**\*Some Assembly Required\***



Soft Grip: Non-slip foam material surrounds the telescoping tube for a comfortable grip and insulation.

## TELESCOPING LANCES (high pressure)

Professional telescopic lances with high pressure hose for easy cleaning of hard to reach areas.

ORDER #	TEMP.	MATERIAL	FLOW RATE	LENGTH	# of SECTIONS	WEIGHT
710086651	212° F	Aluminum / Fiberglass	8 GPM	6-12 feet	2	8.7 lb
710086650	212° F	Aluminum / Fiberglass	8 GPM	6-18 feet	3	10.55 lb
710086652	212° F	Aluminum / Fiberglass	8 GPM	6-18 feet	3	10.50 lb
710086653	212° F	Aluminum / Fiberglass	8 GPM	8-24 feet	3	13.00 lb
710086654	302° F	Aluminum	10.5 GPM	8-24 feet	3	13.50 lb

PRESSURE	INLET	OUTLET
4000 PSI	3/8" F	QC Socket

- Easily clean high to reach areas without leaving the ground or using a lift.
- Ergonomic handle with insulated grip area and ball valve.
- Paired with the ST-602 spray gun.
- Easily attach a turbo nozzle or brush.
- Non slip molded handle.
- Smooth, industrial, and ultra flexible hose.
- **Up to 30% lighter than comparable competition products.**

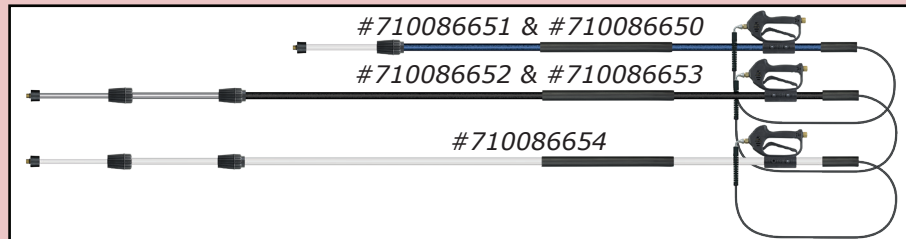

## UNDERBODY LANCE

Ideal for rinsing mud, dirt, snow or salt from under your car/truck underbody. Comes with our ST-601 Inline Spray Gun or ST-601 Weep Inline Spray Gun. Connects to your existing pressure washer. Light in weight and rolls easy with a long reach.

ORDER #	SPRAY GUN	PRESSURE	TEMP.	INLET	LENGTH	WEIGHT
200097810	ST-601	3000 PSI	300° F	3/8" F	67 in	6 lb
200097813	ST-601 Weep	3000 PSI	300° F	3/8" F	67 in	6 lb

- Lightweight and rolls easily for a long reach.
- Remove mud, dirt, snow or salt from the underbody of your vehicle.
- Stainless steel lance.
- Comes with the ST-601 Inline Spray Gun and connects to existing pressure washer hose.
- The ergonomic lance reduces fatigue.
- Uses (3) threaded MEG nozzles.



Comes w/ (3) 25° #2 1/8 MEG nozzles



**See in action!**

<https://www.youtube.com/watch?v=x2DioXXmfbk>

# LANCE: ACCESSORIES

## UNDERBODY LANCE HOLDER

ORDER #	DIMENSIONS (H x W x D)	WEIGHT
040000321	1.38 x 9.63 x 2.25 inches	.55 lb

- Easy storage for the underbody lance.
- Pre-drilled holes for mounting.
- Stainless steel.



Underbody lance shown here on underbody lance holder. Products sold separately.

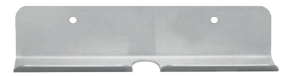

## LANCE HOLDER MOUNT

ORDER #	DESCRIPTION	DIMENSIONS (H x W x D)	WEIGHT
040002055	Mounting bracket for spray guns / lances	2.25 x 8.81 x 2.31 inches	.85 lb

- Mounting bracket for spray guns / lances.
- Perfect for mounting Suttner's ST-175 foam to rinse lance.
- Stainless steel.



Gun/lance shown here on lance holder mount.

Products sold separately.



## LANCE HOLDER

ORDER #	LENGTH	DIAMETER	WEIGHT
105630	21.65 in.	2.36 in	3.8 lb

- Easily store lances when not in use.
- Stainless steel.

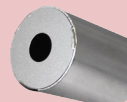

Diameter



Assembly shown in lance holder. Products sold separately.

## TEMPERATURE GAUGE

- Mounts easily to any spray lance.
- Available for 1/4" (200097425) lance.
- Simple way to monitor water temperature.
- Great tool for service technicians.

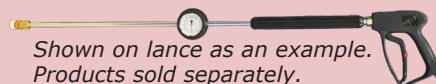

Shown on lance as an example. Products sold separately.



## LANCE BENDER (stainless steel)

Stainless steel lance bender for 1/4" lances

ORDER #	MATERIAL	SIZE	WEIGHT
040003600	Stainless Steel	1/4" Lances	.60 lb

- Saves time and money.
- Great for service trucks.
- Add 15° to your own lances.



See in action!

[www.youtube.com/watch?v=5GvPLgE\\_7b4](http://www.youtube.com/watch?v=5GvPLgE_7b4)

## ALSO AVAILABLE:

### 15° Bend Available On All Lances

- Added charge for bend.
- When placing order to bend, add "B" to end of part number (example: 070000470B).



# LANCE: ACCESSORIES

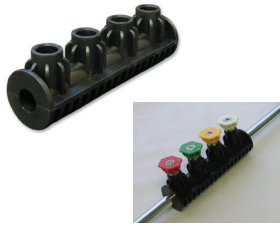

## **NOZZLE HOLDER** (for 1/4" lance)

Easy access to nozzles

ORDER #	MATERIAL	TEMP.	WEIGHT
020002515	Soft durable polymer	150° F	.10 lb

- Holds (4) of your most commonly used 1/4" Quick Connect nozzles for quick and easy access



## **ST-2 LANCE INSULATOR**

Insulates a bare lance and conforms to the curvature of the hand allowing for longer working hours.

ORDER #	TEMP.	LENGTH	WEIGHT	BOX QTY
200002510	300° F	12 in	.28 lb	50

- Easily adjusts anywhere on lance for anyone's desired ergonomic position.
- Durable hardened plastic.



## **ST-009 LANCE HANDLES**

Helps manage the lance with ease and work longer hours.

ORDER #	DESCRIPTION	WEIGHT	MATERIAL	BOX QTY
200009600	Secures to any 1/4" lance	.28 lb	Brass	200
200009603	Secures to any 1/4" lance	.30 lb	Stainless Steel	—
200009700	Secures to molded grip	.28 lb	—	—

- #200009600 & #200009603 easily adjusts anywhere on a 1/4" metal lance for anyone's desired position.
- #200009700 easily adjusts anywhere on a Suttner molded grip lance for anyone's desired ergonomic position.
- Hand fits comfortably and secure around "star shaped" grip.



## **ST-9 & ST-9H VENTED LANCE GRIPS**

ORDER #	DESCRIPTION	LENGTH	WEIGHT	BOX QTY
200009510	Vented grip	15 in	.38 lb	100
200009520	Vented grip w/ side handle	15 in	.62 lb	100

- Vented grip allows heat to dissipate providing a cooler handle.
- Easily adjusts anywhere on lance for anyone's desired ergonomic position.
- Fits 1/4 inch lances.

# NOZZLES

NOZZLE CHART: 46

QUICK CONNECTS: 47

THREADED: 49

NOZZLE PROTECTORS: 51

TURBO NOZZLE CHARTS: 52

TURBOS: 53

HYDRO EXCAVATING TURBOS: 56

ADJUSTABLE: 59

SPECIALITY: 60

MULTI-REG: 61

NOZZLE ACCESSORIES: 62

SEWER NOZZLES: 63



# NOZZLES: NOZZLE CHART

## CHOOSING THE RIGHT NOZZLE ORIFICE SIZE FOR YOUR MACHINE

The orifice size of the nozzle determines the operating pressure of your machine. As a rule of thumb, the smaller the orifice, the greater the restriction of water flowing through the machine. This causes the pressure to increase.

- Choosing a nozzle with too large an orifice will reduce operating pressure.
- Choosing a nozzle with too small an orifice will limit water flow and possibly create an excessive load on the machine.

Nozzle Orifice Size	Pounds Per Square Inch (PSI)																			
	500 PSI	600 PSI	700 PSI	800 PSI	1000 PSI	1500 PSI	2000 PSI	2500 PSI	3000 PSI	3500 PSI	4000 PSI	4500 PSI	5000 PSI	5500 PSI	6000 PSI	6500 PSI	7000 PSI	7500 PSI	8000 PSI	
2	.71	.77	.84	.89	1.0	1.2	1.4	1.6	1.7	1.9	2.0	2.1	2.2	2.3	2.4	2.5	2.6	2.7	2.8	
2.5	.9	1.0	1.0	1.1	1.3	1.6	1.8	2.0	2.2	2.3	2.5	2.7	2.8	2.9	3.1	3.2	3.3	3.4	3.5	
3.0	1.1	1.2	1.3	1.4	1.5	1.8	2.1	2.4	2.6	2.8	3.0	3.2	3.4	3.5	3.7	3.8	4.0	4.1	4.2	
3.5	1.3	1.4	1.5	1.6	1.8	2.2	2.5	2.8	3.1	3.3	3.5	3.7	3.9	4.1	4.3	4.5	4.6	4.8	4.9	
4.0	1.4	1.6	1.7	1.8	2.0	2.5	2.8	3.2	3.5	3.7	4.0	4.2	4.5	4.7	4.9	5.1	5.3	5.5	5.7	
4.5	1.6	1.7	1.9	2.0	2.3	2.8	3.2	3.6	3.9	4.2	4.5	4.8	5.0	5.3	5.5	5.7	6.0	6.2	6.4	
5.0	1.8	1.9	2.1	2.2	2.5	3.1	3.5	4.0	4.3	4.7	5.0	5.3	5.6	5.9	6.1	6.4	6.6	6.8	7.1	
5.5	1.9	2.1	2.3	2.5	2.8	3.4	3.9	4.3	4.8	5.1	5.5	5.8	6.2	6.4	6.7	7.0	7.3	7.5	7.8	
6.0	2.1	2.3	2.5	2.7	3.0	3.7	4.2	4.7	5.2	5.6	6.0	6.4	6.7	7.0	7.3	7.6	7.9	8.2	8.5	
6.5	2.3	2.5	2.7	2.9	3.3	4.0	4.6	5.1	5.6	6.1	6.5	6.9	7.3	7.6	8.0	8.3	8.6	8.9	9.2	
7.0	2.5	2.7	2.9	3.1	3.5	4.3	4.9	5.5	6.1	6.5	7.0	7.4	7.8	8.2	8.6	8.9	9.3	9.6	9.9	
7.5	2.7	2.9	3.1	3.4	3.8	4.6	5.3	5.9	6.5	7.0	7.5	8.0	8.4	8.8	9.2	9.6	9.9	10.3	10.6	
8.0	2.8	3.1	3.4	3.6	4.0	4.9	5.7	6.3	6.9	7.5	8.0	8.5	8.9	9.4	9.8	10.2	10.6	11.0	11.3	
9.0	3.2	3.5	3.8	4.0	4.5	5.5	6.4	7.1	7.8	8.4	9.0	9.6	10.1	10.6	11.0	11.5	11.9	12.3	12.7	
10	3.5	3.9	4.2	4.5	5.0	6.1	7.1	7.9	8.7	9.4	10.0	10.6	11.2	11.7	12.2	12.7	13.2	13.7	14.1	
12	4.2	4.6	5.0	5.4	6.0	7.3	8.5	9.5	10.4	11.2	12.0	12.7	13.4	14.1	14.7	15.3	15.9	16.4	17.0	
15	5.3	5.8	6.3	6.7	7.5	9.2	10.6	11.9	13.0	14.1	15.0	15.9	16.8	17.6	18.4	19.1	19.8	20.5	21.2	

Use the table to select the properly sized nozzle for your machine. Determine the nozzle size by matching the operating pressure (PSI) of your machine to the gallons per minute (GPM).

### RED 0° NOZZLE

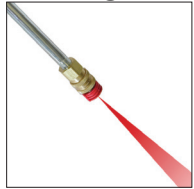

**USES:**  
Removing weeds from sidewalk cracks, stubborn stains and chewing gum from concrete, masonry, aluminum, steel, caked mud and cleaning under lawn mowers.

This is a blasting nozzle. It delivers a very concentrated stream of water. Care should be used to avoid gouging wood or damaging fragile surfaces.

### YELLOW 15° NOZZLE

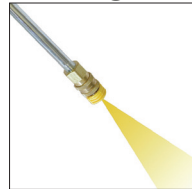

**USES:**  
Surface preparation (removing peeling paint and mildew stains), cleaning gutters, downspouts, removing bugs and grime from cars and trucks.

This is a chiseling nozzle. The spray should be directed at a 45° angle to the surface and used like a scraper to remove paint, grease and dirt.

### GREEN 25° NOZZLE

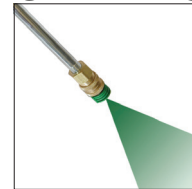

**USES:**  
Wet-sweeping leaves from walks, curbs and driveways, cleaning stable floors, washing swimming pools and cleaning barbecue grills.

This is a flushing nozzle. With a more narrow spray pattern than the 40° nozzle and with more concentrated spray pressure, this nozzle is best suited for flushing dirt, mud and grime.

### WHITE 40° NOZZLE



**USES:**  
Washing down siding on homes, cleaning windows, washing vehicles, spraying sidewalks, driveways and patios.

This is a wash nozzle. Its wide spray pattern disperses the water pressure over a large area and is recommended for rinsing and moderate washing.

### BLACK 65° NOZZLE

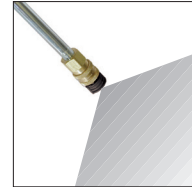

**USES:**  
For applications using soaps and chemicals. Wide spray angle allows for even and broad applications for use on cars, siding and patios.

This is a soap nozzle. Its wide angle spray pattern disperses soaps or chemicals over a large area.

# NOZZLES: QUICK CONNECT

## QUICK CONNECT NOZZLES

For applications requiring quick exchange of different degree nozzles.

ORIFICE SIZE	0° (Red)	15° (Yellow)	25° (Green)	40° (White)
2.0	—	900001520	900002520	900004020
2.5	—	900001525	900002525	—
3.0	900000D30	900001530	900002530	900004030
3.5	900000D35	900001535	900002535	900004035
4.0	900000D40	900001540	900002540	900004040
4.5	900000D45	900001545	900002545	900004045
5.0	900000D50	900001550	900002550	900004050
5.5	900000D55	900001555	900002555	900004055
6.0	900000D60	900001560	900002560	900004060
6.5	900000D65	900001565	900002565	900004065
7.0	900000D70	900001570	900002570	900004070
7.5	900000D75	900001575	900002575	900004075
8.0	900000D80	900001580	900002580	900004080
9.0	900000D90	900001590	900002590	900004090
10.0	900000D10	900001510	900002510	900004010
12.0	900000D12	900001512	900002512	900004012
15.0	900000D15	900001515	900002515	900004015
20.0	900000D20	900015D20	—	—
30.0 Special Order	—	900015D30	—	—
35.0 Special Order	—	900015D35	—	—

- 1/4" quick connect or disconnect design.
- Spray angles range from high impact solid stream to 0° to 40° flat spray.
- QCMEG include color coded protective nozzle guards identify nozzle degree.
- Pressure: 4000 PSI.

## ALSO AVAILABLE:

### Quick Connect Soap Nozzle

ORIFICE SIZE	25° SOAP (Black)	65° SOAP (Black)
40.0	9000S2540	—
40.0	—	839006540

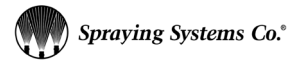

Available in Sets of 5  
#999504000



[www.youtube.com/watch?v=GRvP8CQBDas](http://www.youtube.com/watch?v=GRvP8CQBDas)



#9000S2540  
Soap Nozzle

# NOZZLES: QUICK CONNECT



Available in Sets of 5  
#999544000



Degree marked on nozzles

#4000S6540  
65° x 40  
Soap Nozzle



## ECONOMY QUICK CONNECT NOZZLES

For applications requiring quick exchange of different degree nozzles.

ORIFICE SIZE	0° (Red)	15° (Yellow)	25° (Green)	40° (White)
2.0	—	400001520	400002520	400004020
2.5	—	400001525	400002525	—
3.0	400000D30	400001530	400002530	400004030
3.5	400000D35	400001535	400002535	400004035
4.0	400000D40	400001540	400002540	400004040
4.5	400000D45	400001545	400002545	400004045
5.0	400000D50	400001550	400002550	400004050
5.5	400000D55	400001555	400002555	400004055
6.0	400000D60	400001560	400002560	400004060
6.5	400000D65	400001565	400002565	400004065
7.0	400000D70	400001570	400002570	400004070
7.5	400000D75	400001575	400002575	400004075
8.0	400000D80	400001580	400002580	400004080
8.5	400000D85	400001585	400002585	400004085
9.0	400000D90	400001590	400002590	400004090
10.0	400000D10	400001510	400002510	400004010
12.0	400000D12	400001512	400002512	400004012
15.0	400000D15	400001515	400002515	—
20.0	40000DD20	—	—	—

- 1/4" quick connect or disconnect design.
- Spray angles range from high impact solid stream to 0° to 40° flat spray.
- QCMEG include color coded protective nozzle guards identify nozzle degree.
- Pressure: 4000 PSI.

## QUICK CONNECT NOZZLES SETS

ORDER #	PRESSURE	TEMP.	NOZZLE SIZE	COLOR
125852040	5076 PSI	300° F	4.0	Brown
125852045	5076 PSI	300° F	4.5	Green
125852050	5076 PSI	300° F	5.0	Black
125852070	5076 PSI	300° F	7.0	Orange

- Easily change from one nozzle to another.
- Nozzle spray angles: 0°, 15°, 40° and soap nozzle.
- Professional stainless steel nozzle inserts.
- Different color for different nozzle sizes.

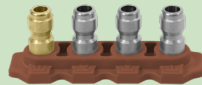
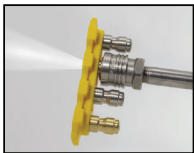

#125852040



#125852050

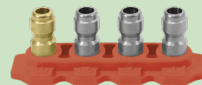

#125852070

# NOZZLES: THREADED

## 1/8" MPT NOZZLES (hardened stainless steel)

Ideal for one nozzle applications and quick exchange is not needed.

ORIFICE SIZE	15°	25°	40°	50°	65°
1.0	828001501	—	—	—	—
1.5	828015015	—	—	—	—
2.0	—	828025020	—	—	828506520
2.5	828015025	—	—	—	—
3.0	828201530	—	828404030	—	—
3.5	828015035	—	—	—	—
4.0	828401540	828402540	828404040	—	—
4.5	828401545	828402545	—	—	—
5.0	828601550	—	—	828505050	828506550
5.5	828601555	—	—	—	—
6.0	—	828602560	—	—	—
6.5	828601565	828602565	—	—	—
7.0	—	828702570	—	828505070	—
8.0	—	—	—	—	828506580
10.0	—	—	828104010	—	—
15.0	828501515	—	—	—	—

- Spray angles range from high impact solid stream 15° to 65° flat spray.
- Produce a uniform distribution of small to medium sized drops.
- Pressure: 4000 PSI.

### ALSO AVAILABLE:

15° Soap (brass)

ORIFICE SIZE	15° (Soap)
15.0	828BR1515
50.0	828BR5050



**\*Minimal quantities required for special order nozzles**



## 1/4" FPT NOZZLES (hardened stainless steel)

Ideal for one nozzle applications and when quick exchange is not needed.

ORIFICE SIZE	0°	15°	25°	40°
4.0	9WEG0D040	9WEG15040	9WEG25040	9WEG40040
4.5	—	9WEG15045	9WEG25045	9WEG40045
5.0	9WEG0D005	9WEG15050	9WEG25050	9WEG40050
5.5	9WEG0D055	9WEG15055	9WEG25055	9WEG40055
6.0	9WEG0D006	—	9WEG25060	9WEG40060
7.0	—	9WEG15070	9WEG25070	9WEG40070
8.0	9WEG0D008	9WEG15080	9WEG25080	9WEG40080
9.0	—	9WEG15090	9WEG25090	9WEG40090
10.0	9WEG00D10	9WEG01510	9WEG02510	9WEG04010

- Spray angles range from high impact solid stream 0° to a 40°.
- Pressure: 4000 PSI.



Spraying Systems Co.®

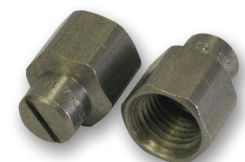

# NOZZLES: THREADED



## 1/4" MPT NOZZLES (hardened stainless steel)

Ideal for one nozzle applications and quick exchange is not needed.

ORIFICE SIZE	0°	5°	15°	25°	40°	50°	65°
1.0	—	—	—	820202501	820204010	—	—
1.5	—	—	—	820202515	—	—	—
2.0	820200020	820300502	820201520	820202520	820204020	—	820206502
3.0	820200003	—	820201530	820202530	820204030	—	820306530
3.5	820200035	—	820201535	820202535	820204035	—	—
4.0	820300004	820300504	820301540	820302540	820304040	—	820306540
4.5	820400045	—	820401545	820402545	820404045	—	820406545
5.0	820500005	—	820501550	820502550	820504050	—	820506550
5.5	820600055	—	820601555	820602555	820604055	—	820606555
6.0	820700006	—	820701560	820702560	820704060	820705060	820706560
6.5	820700065	—	820701565	820702565	820704065	—	—
7.0	820800007	—	820801570	820802570	820804070	—	—
7.5	—	—	820801575	—	—	—	—
8.0	820900008	—	820901580	820902580	820904080	—	820906508
9.0	—	—	820901509	—	820904090	820905090	820906509
10.0	821000010	—	821001510	821002510	821004010	—	821006510
11.0	—	—	821001511	—	—	—	—
12.0	821000012	821500512	821001512	821002512	821004012	—	—
15.0	821000015	821500515	821001515	821002515	821504015	—	821006515
20.0	821000020	821500520	821501520	821002520	821504020	821005020	821006520
25.0	821500025	—	821501525	821502525	821004025	—	—
30.0	821000030	821500530	821601530	821002530	821604030	—	821006530
35.0	821000035	—	821001535	821002535	821604035	—	—
40.0	821000040	—	821001540	821002540	821004040	—	821006540
50.0	821000050	—	821001550	—	821004050	—	—
60.0	821000060	821500560	—	821002560	—	—	—

- Spray angles range from high impact solid stream 0° to 65° flat spray.
- Produce an uniform distribution of small to medium sized drops.
- Pressure: 4000 PSI.

## 1/4" MPT VEEJET NOZZLES (brass)

Ideal for one nozzle applications and when quick exchange is not needed.



Spraying Systems Co.®



ORIFICE SIZE	0°	15°	25°	40°	50°	65°	80°
10.0	—	—	8110S2510	8110S4010	—	—	—
15.0	—	—	8110S2515	—	—	—	—
20.0	8110S0020	8110S1520	8110S2520	8110S4020	—	—	8110S8020
30.0	8110S0030	820051530	8110S2530	8110S4030	—	—	—
40.0	—	—	8110S2540	—	—	8110S6540	—
50.0	8110S0050	—	8110S2550	8110S4050	8120S5050	—	—
60.0	8110S0060	—	8110S2560	8110S4060	—	—	—
70.0	—	—	8110S2570	—	—	—	—

- Pressure: 4000 PSI.

### ALSO AVAILABLE:

ORIFICE SIZE	25°	65°	110°
1.0	—	—	811S11001 (S.S)
10.0	812SS2510 (S.S)	8110S6510 (B.R)	—

- High impact spray pattern.

## ST-004 NOZZLE PROTECTORS W/ BUSHINGS (protects the cleaning surface)

ORDER #	INLET	OUTLET	WEIGHT
200000003	1/4" FPT	1/4" FPT	.10 lb
200000004	1/4" FPT	1/8" FPT	.10 lb

- Nozzle protection for 1/4" or 1/8" threaded nozzles
- Easy access to your nozzle



## ST-10 NOZZLE PROTECTORS (soft edge, hard body)

Nozzle protection for 1/4" threaded nozzles. Ideal for protecting sensitive surfaces against damage, such as car washing.

ORDER #	MATERIAL	TEMP.	INLET	OUTLET	WEIGHT
200010520	Zinc Plated	300° F	1/4" FPT	1/4" FPT	.10 lb
200010530	Zinc Plated	300° F	1/4" FPT	1/4" FPT	.10 lb
200010720	Stainless Steel	300° F	1/4" FPT	1/4" FPT	.10 lb

- Damage is prevented since nozzle is surrounded by protector and provides additional protection with its soft edge.

### ALSO AVAILABLE:

Multiple colors: Special order, minimum quantities Zinc plated or stainless steel.



Red/Black  
#200010520 Zinc Plated  
#200010720 Stainless Steel



Black/Gray  
#200010530 Zinc Plated

## ST-11 NOZZLE PROTECTORS

ORDER #	TEMP.	WEIGHT	COLOR
020001123	300° F	0.2 lb	Yellow
020001149	300° F	0.2 lb	Blue
020001122	300° F	0.2 lb	Green
020001121	300° F	0.2 lb	Red

- The nozzle protector ST-11 suitable for nozzles 1/4" M.

**FOOD  
GRADE**

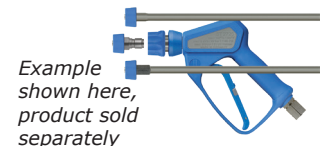

Example shown here, product sold separately

# NOZZLES: TURBO NOZZLE CHARTS

**NEW!**

## **TURBO NOZZLE IDENTIFICATION CHART:**



**3.0**  
Yellow



**3.5**  
Purple



**4.0**  
Brown



**4.5**  
Light Green



**5.0**  
Black



**5.5**  
Light Blue



**6.0**  
Red



**7.0**  
Pink



**8.0**  
Orange













**9.0**  
Green



**10.0**  
Gray

## **TURBO NOZZLE CHART:**

									
	<b>ST-357</b>	<b>ST-456</b>	<b>ST-457</b>	<b>ST-457H</b>	<b>ST-458</b>	<b>ST-458 Hydro-Ex</b>	<b>ST-458H</b>	<b>ST-559</b>	<b>8°</b>
<b>Page #</b>	53	53	54	56	54	57	57	55	56
<b>Pressure Rating</b>	3625 PSI	5070 PSI	6000 PSI	6000 PSI	6000 PSI	6000 PSI	6000 PSI	8700 PSI	6000 PSI
<b>Temp.</b>	190°F	212°F	212°F	212°F	212°F	190°F	212°F	190°F	190°F
<b>Orifice Sizes</b>	3.0 - 10.0	3.0 - 10.0	3.0 - 10.0	3.0 - 10.0	11.0 - 30.0	3.0 - 12.0	12.0 - 25.0	2.0 - 6.0	8.0 & 10.0
<b>Inlet</b>	1/4" FPT	1/4" FPT	1/4" FPT	1/2" FPT	1/4" FPT	1/2" F	1/2" FPT	1/4" FPT	1/2" FPT
<b>Hydro-Ex</b>	—	—	✓	✓	✓	✓	✓	—	✓
<b>Cover</b>	✓	✓	✓	✓	✓	✓	✓	—	—
<b>Rotor &amp; Seat Materials</b>	Ceramic	Ceramic	Ceramic	Ceramic	Ceramic	Ceramic	Ceramic	Tungsten Carbide	Ceramic
<b>Housing Materials</b>	Brass	Brass	Brass	Brass	Brass	Brass	Brass	Poly	Stainless Steel

## ST-357 TURBO NOZZLES

The increased tearing action of the rotating spray is ideal for hard surface applications, such as concrete graffiti cleaning or caked on mud on heavy equipment.

ORDER #	PRESSURE	TEMP.	ORIFICE	INLET	WEIGHT	REPAIR KIT
200357530	3625 PSI	190° F	3.0	1/4" FPT	.68 lb	200357130
200357535	3625 PSI	190° F	3.5	1/4" FPT	.68 lb	200357135
200357540	3625 PSI	190° F	4.0	1/4" FPT	.68 lb	200357140
200357545	3625 PSI	190° F	4.5	1/4" FPT	.68 lb	200357145
200357550	3625 PSI	190° F	5.0	1/4" FPT	.68 lb	200357150
200357555	3625 PSI	190° F	5.5	1/4" FPT	.68 lb	200357155
200357560	3625 PSI	190° F	6.0	1/4" FPT	.68 lb	200357160
200357570	3625 PSI	190° F	7.0	1/4" FPT	.68 lb	200357170
200357580	3625 PSI	190° F	8.0	1/4" FPT	.68 lb	200357180
200357590	3625 PSI	190° F	9.0	1/4" FPT	.68 lb	200357190
200357510	3625 PSI	190° F	10.0	1/4" FPT	.68 lb	200357110

- Increases cleaning efficiency as much as 200%.
- The 0° rotation creates a cleaning and tearing action.
- Minimum 1000 PSI.
- Ideal for hard surfaces.
- Improved materials for a longer life.
- Orifice size stamped on inlet nut.
- Box quantity: 50.

## 3625 PSI



**ALWAYS START TURBO NOZZLE IN A DOWNWARD POSITION.**

**THE USE OF A TURBO STRAINER IS RECOMMENDED FOR ALL TURBO NOZZLES.**

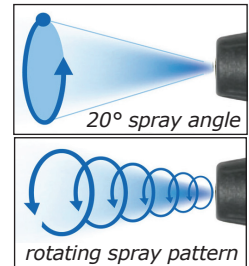

## ST-456 TURBO NOZZLES

The increased tearing action of the rotating spray is ideal for hard surface applications, such as concrete graffiti cleaning or caked mud.

ORDER #	PRESSURE	TEMP.	ORIFICE	INLET	WEIGHT	REPAIR KIT
200456530	5070 PSI	212° F	3.0	1/4" FPT	.9 lb	200456130
200456535	5070 PSI	212° F	3.5	1/4" FPT	.9 lb	200456135
200456540	5070 PSI	212° F	4.0	1/4" FPT	.9 lb	200456140
200456545	5070 PSI	212° F	4.5	1/4" FPT	.9 lb	200456145
200456550	5070 PSI	212° F	5.0	1/4" FPT	.9 lb	200456150
200456555	5070 PSI	212° F	5.5	1/4" FPT	.9 lb	200456155
200456560	5070 PSI	212° F	6.0	1/4" FPT	.9 lb	200456160
200456570	5070 PSI	212° F	7.0	1/4" FPT	.9 lb	200456170
200456580	5070 PSI	212° F	8.0	1/4" FPT	.9 lb	200456180

- Increases cleaning efficiency as much as 200%.
- The 0° rotation creates a cleaning and tearing action.
- Minimum 1000 PSI.
- Improved materials for a longer life.
- Orifice size stamped on inlet nut.
- Box quantity: 25.

## 5070 PSI



**ALWAYS START TURBO NOZZLE IN A DOWNWARD POSITION.**

**THE USE OF A TURBO STRAINER IS RECOMMENDED FOR ALL TURBO NOZZLES.**

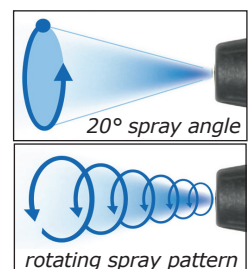

# NOZZLES: TURBO

## 6000 PSI



**ALWAYS START TURBO NOZZLE IN A DOWNWARD POSITION.**

**THE USE OF A TURBO STRAINER IS RECOMMENDED FOR ALL TURBO NOZZLES.**

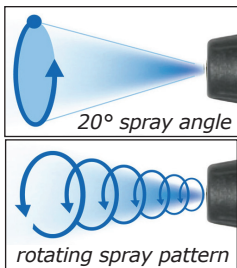

### ST-457 TURBO NOZZLES

The increased tearing action of the rotating spray is ideal for hard surface applications, such as concrete graffiti cleaning or caked on mud on heavy equipment.

ORDER #	PRESSURE	TEMP.	ORIFICE	INLET	WEIGHT	REPAIR KIT
200457530	6000 PSI	212° F	3.0	1/4" FPT	1.48 lb	200457130
200457535	6000 PSI	212° F	3.5	1/4" FPT	1.48 lb	200457135
200457540	6000 PSI	212° F	4.0	1/4" FPT	1.48 lb	200457140
200457545	6000 PSI	212° F	4.5	1/4" FPT	1.48 lb	200457145
200457550	6000 PSI	212° F	5.0	1/4" FPT	1.48 lb	200457150
200457555	6000 PSI	212° F	5.5	1/4" FPT	1.48 lb	200457155
200457560	6000 PSI	212° F	6.0	1/4" FPT	1.48 lb	200457160
200457570	6000 PSI	212° F	7.0	1/4" FPT	1.48 lb	200457170
200457580	6000 PSI	212° F	8.0	1/4" FPT	1.48 lb	200457180
200457590	6000 PSI	212° F	9.0	1/4" FPT	1.48 lb	200457190
200457510	6000 PSI	212° F	10.0	1/4" FPT	1.48 lb	200457110

- Increases cleaning efficiency as much as 200%.
- The 0° rotation creates a cleaning and tearing action.
- Minimum 1000 PSI.
- Improved materials for a longer life.
- Orifice size stamped on inlet nut.
- Box quantity: 20.

## 6000 PSI



**ALWAYS START TURBO NOZZLE IN A DOWNWARD POSITION.**

**THE USE OF A TURBO STRAINER IS RECOMMENDED FOR ALL TURBO NOZZLES.**

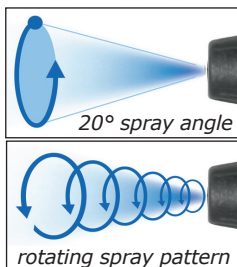

### ST-458 TURBO NOZZLES

The increased tearing action of the rotating spray is ideal for hard surface applications, such as concrete graffiti cleaning or caked on mud on heavy equipment.

ORDER #	PRESSURE	TEMP.	ORIFICE	INLET	WEIGHT	REPAIR KIT
200458811	6000 PSI	212° F	11.0	1/4" FPT	1.60 lb	200458311
200458812	6000 PSI	212° F	12.0	1/4" FPT	1.60 lb	200458312
200458815	6000 PSI	212° F	15.0	1/4" FPT	1.60 lb	200458315
200458820	6000 PSI	212° F	20.0	1/4" FPT	1.60 lb	200458320
200458825	6000 PSI	212° F	25.0	1/4" FPT	1.60 lb	200458325
200458830	6000 PSI	212° F	30.0	1/4" FPT	1.60 lb	200458330

- Increases cleaning efficiency as much as 200%.
- The 0° rotation creates a cleaning and tearing action.
- Minimum 1000 PSI.
- Improved materials for a longer life.
- Orifice size stamped on inlet nut.
- Box quantity: 25.
- **Special order: Orifice size 11.0.**

## ST-559 TURBO NOZZLES (tungsten carbide nozzle & seat)

The increased tearing action of the rotating spray is ideal for hard surface applications, such as concrete graffiti cleaning or caked on mud on heavy equipment.

ORDER #	PRESSURE	TEMP.	ORIFICE	INLET	WEIGHT	REPAIR KIT
200559620	8700 PSI	190° F	2.0	1/4" FPT	1.32 lb	200559120
200559630	8700 PSI	190° F	3.0	1/4" FPT	1.32 lb	200559130
200559640	8700 PSI	190° F	4.0	1/4" FPT	1.32 lb	200559140
200559650	8700 PSI	190° F	5.0	1/4" FPT	1.32 lb	200559150
200559655	8700 PSI	190° F	5.5	1/4" FPT	1.32 lb	200559155
200559660	8700 PSI	190° F	6.0	1/4" FPT	1.32 lb	200559160

- Increases cleaning efficiency as much as 200%.
- The 0° rotation creates a cleaning and tearing action.
- Ideal for hard surfaces.
- Improved materials for a longer life.
- Tungsten carbide nozzle and sealing seat.
- Orifice size stamped on inlet nut.



**ALSO AVAILABLE:** 1/2" Inlet (minimum quantities)

## 8700 PSI



**ALWAYS START TURBO NOZZLE IN A DOWNWARD POSITION.**

**THE USE OF A TURBO STRAINER IS RECOMMENDED FOR ALL TURBO NOZZLES.**

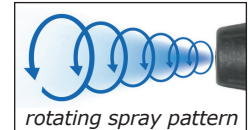
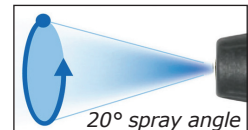

## ST-415 TURBO NOZZLES (rotating spray pattern)

Ideal for hard surface cleaning such as decks and concrete. Perfect for residential machines.

ORDER #	PRESSURE	TEMP.	ORIFICE	INLET	WEIGHT
200415505	1750 PSI	140° F	3.5	1/4" FPT	.10 lb

- Increases cleaning efficiency as much as 200%.
- The 0° rotation creates a cleaning and tearing action.
- Improved materials for longer life.
- Ideal for hard surfaces.

## 1750 PSI



**ALWAYS START TURBO NOZZLE IN A DOWNWARD POSITION.**

**THE USE OF A TURBO STRAINER IS RECOMMENDED FOR ALL TURBO NOZZLES.**

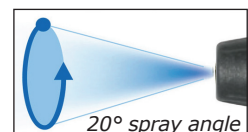

# NOZZLES: HYDRO EXCAVATION

**NEW!**

**6000 PSI**



**ALWAYS START TURBO NOZZLE IN A DOWNWARD POSITION.**

**THE USE OF A TURBO STRAINER IS RECOMMENDED FOR ALL TURBO NOZZLES.**

## **8° TURBO NOZZLES** (stainless steel)

ORDER #	PRESSURE	TEMP.	ORIFICE	INLET	WEIGHT
200556512	6000 PSI	190° F	10.0	1/2" FPT	1.0 lb
200556582	6000 PSI	190° F	8.0	1/2" FPT	1.0 lb

- 8° spray angle.
- Extremely aggressive jet.
- Length: 6 inches.
- Chemical resistant housing.
- **Ideal for hydro excavating.**
- **Also available with a cover #200556599.**
- Increases cleaning efficiency as much as 200%.
- The 0° rotation creates a cleaning and tearing action.
- Ideal for hard surfaces.
- Improved materials for a longer life.
- Tungsten carbide nozzle and sealing seat.

**6000 PSI**



**ALWAYS START TURBO NOZZLE IN A DOWNWARD POSITION.**

**THE USE OF A TURBO STRAINER IS RECOMMENDED FOR ALL TURBO NOZZLES.**

## **ST-457H TURBO NOZZLES**

ORDER #	PRESSURE	TEMP.	ORIFICE	INLET	WEIGHT	REPAIR KIT
200457730	6000 PSI	212° F	3.0	1/2" FPT	1.48 lb	200457130
200457735	6000 PSI	212° F	3.5	1/2" FPT	1.48 lb	200457135
200457745	6000 PSI	212° F	4.5	1/2" FPT	1.48 lb	200457145
200457750	6000 PSI	212° F	5.0	1/2" FPT	1.48 lb	200457150
200457755	6000 PSI	212° F	5.5	1/2" FPT	1.48 lb	200457155
200457760	6000 PSI	212° F	6.0	1/2" FPT	1.48 lb	200457160
200457770	6000 PSI	212° F	7.0	1/2" FPT	1.48 lb	200457170
200457780	6000 PSI	212° F	8.0	1/2" FPT	1.48 lb	200457180
200457790	6000 PSI	212° F	9.0	1/2" FPT	1.48 lb	200457190
200457710	6000 PSI	212° F	10.0	1/2" FPT	1.48 lb	200457110

- Increases cleaning efficiency as much as 200%.
- The 0° rotation creates a cleaning and tearing action.
- Ideal for hard surfaces.
- Minimum 1000 PSI.
- Ideal for hard surfaces.
- Improved materials for a longer life.
- **Ideal for hydro excavating.**
- Orifice size stamped on inlet nut.
- Box quantity: 20.

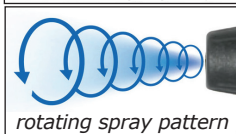
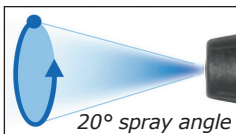

# NOZZLES: HYDRO EXCAVATION

## ST-458 HYDRO EXCAVATING TURBO NOZZLES

ORDER #	PRESSURE	TEMP.	ORIFICE	INLET	WEIGHT	REPAIR KIT
200458982	6000 PSI	190° F	3.0	1/2" F	1.60 lb	200457130
200458983	6000 PSI	190° F	3.5	1/2" F	1.60 lb	200457135
200458984	6000 PSI	190° F	4.0	1/2" F	1.60 lb	200457140
200458985	6000 PSI	190° F	4.5	1/2" F	1.60 lb	200457145
200458986	6000 PSI	190° F	5.0	1/2" F	1.60 lb	200457150
200458987	6000 PSI	190° F	5.5	1/2" F	1.60 lb	200457155
200458988	6000 PSI	190° F	6.0	1/2" F	1.60 lb	200457160
200458990	6000 PSI	190° F	7.0	1/2" F	1.60 lb	200457170
200458981	6000 PSI	190° F	8.0	1/2" F	1.60 lb	200457180
200458991	6000 PSI	190° F	9.0	1/2" F	1.60 lb	200457190
200458992	6000 PSI	190° F	10.0	1/2" F	1.60 lb	200457110
200458993	6000 PSI	190° F	12.0	1/2" F	1.60 lb	200458312

- Added extension to the outlet to help prevent mud and dirt from damaging the seat and rotor.
- Molded and wear resistant poly cover.
- Increases the lifetime of the nozzle significantly.
- Different colors available per request.
- **• Ideal for hydro excavating.**
- Orifice size stamped on inlet nut.
- Box quantity: 20.

**6000 PSI**



**ALWAYS START TURBO NOZZLE IN A DOWNWARD POSITION.**

**THE USE OF A TURBO STRAINER IS RECOMMENDED FOR ALL TURBO NOZZLES.**

## ST-458H TURBO NOZZLES

ORDER #	PRESSURE	TEMP.	ORIFICE	INLET	WEIGHT	REPAIR KIT
200458712	6000 PSI	212° F	12.0	1/2" FPT	1.60 lb	200458312
200458715	6000 PSI	212° F	15.0	1/2" FPT	1.60 lb	200458315
200458720	6000 PSI	212° F	20.0	1/2" FPT	1.60 lb	200458320
200458725	6000 PSI	212° F	25.0	1/2" FPT	1.60 lb	200458325
200458730	6000 PSI	212° F	30.0	1/2" FPT	1.60 lb	200458330

- Increases cleaning efficiency as much as 200%.
- The 0° rotation creates a cleaning and tearing action.
- Minimum 1000 PSI.
- Improved materials for a longer life.
- **• Ideal for hydro excavating.**
- Box quantity: 25.

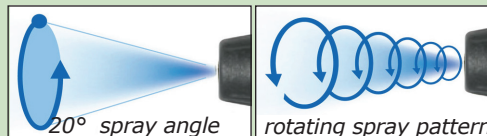

### **ALSO AVAILABLE:**

Without Cap in 12.0 orifice #200458712

**6000 PSI**



**ALWAYS START TURBO NOZZLE IN A DOWNWARD POSITION.**

**THE USE OF A TURBO STRAINER IS RECOMMENDED FOR ALL TURBO NOZZLES.**



# NOZZLES: HYDRO EXCAVATION

## STATIC HYDRO EXCAVATION NOZZLES

Hydro-excavation is fast and effective in all geology types, capable of working at greater depths pneumatic systems.



Front view

ORDER #	PRESSURE	TEMP.	ORIFICE	INLET	WEIGHT
200049420045	4000 PSI	212° F	4.5	1/2" FPT	.25 lb
200049420055	4000 PSI	212° F	5.5	1/2" FPT	.25 lb
200049420060	4000 PSI	212° F	6.0	1/2" FPT	.25 lb
200049420080	4000 PSI	212° F	8.0	1/2" FPT	.25 lb
200049420090	4000 PSI	212° F	9.0	1/2" FPT	.25 lb
200049420100	4000 PSI	212° F	10.0	1/2" FPT	.25 lb
200049420110	4000 PSI	212° F	11.0	1/2" FPT	.25 lb
200049420120	4000 PSI	212° F	12.0	1/2" FPT	.25 lb
200049420130	4000 PSI	212° F	13.0	1/2" FPT	.25 lb
200049420150	4000 PSI	212° F	15.0	1/2" FPT	.25 lb
200049420200	4000 PSI	212° F	20.0	1/2" FPT	.25 lb
200049420300	4000 PSI	212° F	30.0	1/2" FPT	.25 lb
200049420350	4000 PSI	212° F	35.0	1/2" FPT	.25 lb

- (1) Centric front nozzle and (3) 15° front.
- Ideal for areas with access issues.
- Safely remove contaminated materials.
- **• Ideal for hydro excavating.**
- Custom made for customer's machine.
- Hardened stainless steel with durable poly cover.



# NOZZLES: ADJUSTABLE

## ST-51N ADJUSTABLE NOZZLE (high and low pressures)

For use when high and low pressures are needed. For example, spraying cleaning agents with low pressure through an injector valve and then cleaning with high pressure.

ORDER #	PRESSURE	TEMP.	FLOW RATE	INLET	OUTLET	WEIGHT
200051530	3600 PSI	212° F	8 GPM	1/4" FPT	1/4" FPT	.36 lb

- Through twisting the plastic housing the high or low pressure operation is continuously adjustable.
- Dumps water around nozzle to lower pressure.
- The nozzle housing is made of an impact resistant plastic, manufactured or corrosion resistant material.

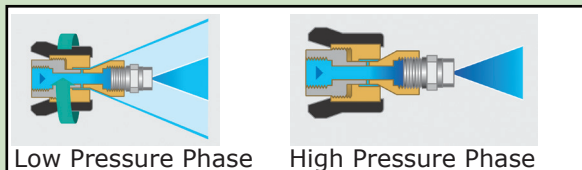

## ST-51.1 VARIABLE SPRAY NOZZLE

ORDER #	PRESSURE	INLET	TEMP.	FLOW RATE	WEIGHT
200051750	900 PSI	1/2" M	190° F	27 GPM	.39 lb

- Adjustable cone sprays from 0° to 90°.
- Stainless steel metal parts and food grade plastic handle.



**NEW!**



## ST-330 ADJUSTABLE NOZZLE HOLDERS (stainless steel)

ORDER #	PRESSURE	TEMP.	FLOW RATE	INLET	OUTLET	WEIGHT
200330500	5070 PSI	300° F	10 GPM	1/4" F	1/4" F	.30 lb
200330501	5070 PSI	300° F	10 GPM	1/4" F	1/4" F	.40 lb
200330510	5070 PSI	300° F	10 GPM	1/4" F	1/4" M	.30 lb
200330540	5070 PSI	300° F	10 GPM	1/4" M	1/4" F	.30 lb

- Stainless steel.
- Perfect for hard to reach areas.
- Adjustable 270° (+/-135°).



**See in action!**

<https://youtu.be/4zkt31t-KL8>



#200330500

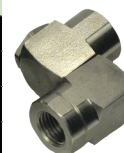

#200330510



#200330501

Locking Handle

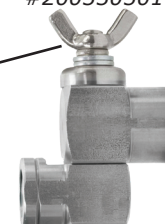

#200330540

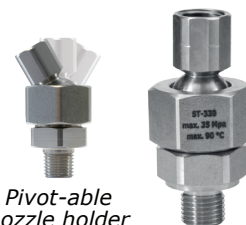

Pivot-able nozzle holder

# NOZZLES: SPECIALTY



Spraying Systems Co.®



Diameter: 1.1875 in

## ADJUSTABLE WASHJET NOZZLES (0° to 80°)

For use when different spray patterns from 0° solid stream to 80° flat spray are needed. No need to switch out nozzle to achieve different spray patterns.

ORDER #	PRESSURE	TEMP.	ORIFICE	INLET	LENGTH	WEIGHT
239900035	3000 PSI	300° F	3.5	1/4" FPT	1.875 in	.20 lb
239900040	3000 PSI	300° F	4.0	1/4" FPT	1.875 in	.20 lb
239900045	3000 PSI	300° F	4.5	1/4" FPT	1.875 in	.20 lb
239900055	3000 PSI	300° F	5.5	1/4" FPT	1.875 in	.20 lb
239900100	3000 PSI	300° F	10.0	1/4" FPT	1.875 in	.20 lb
239900180	3000 PSI	300° F	18.0	1/4" FPT	1.875 in	.20 lb
239900200	3000 PSI	300° F	20.0	1/4" FPT	1.875 in	.20 lb

- Quick and easy spray pattern adjustment from 0° solid stream to 80°
- flat spray with a simple twist of the nozzle head.
- Internal guide vane visual reference for spray alignment.
- Hardened stainless steel orifice for wear resistance and long life.
- Outer covering made of nylon for additional protection.



## ST-52.1 PRESSURE REGULATOR

Control pressure and volume by turning the black housing and restricting water flow. No need to switch nozzle sizes to lower pressure.

ORDER #	PRESSURE	TEMP.	FLOW RATE	INLET	OUTLET	WEIGHT
200052605	5000 PSI	300° F	8 GPM	1/4" MPT	1/4" FPT	.48 lb

- Reduces pressure down to a 500 PSI.



## ST-56 ROLL-OVER NOZZLE (switch nozzles easily)

Switch between two nozzles without stopping. Great for applying soap and then cleaning with high pressure. Popular at tunnel car washes.

ORDER #	PRESSURE	TEMP.	FLOW RATE	INLET	OUTLET	WEIGHT
200056500	3600 PSI	300° F	8 GPM	1/4" FPT	1/4" FPT	.51 lb

- Simply turn over the complete assembly or swivel lance and you have access to two different nozzles.
- Spray depends on nozzles used.
- Water sprays through one nozzle port at a time since a stainless steel ball covers the opposite port.



## ST-58 CHANGE-OVER VALVE (stainless steel)

ORDER #	PRESSURE	TEMP.	INLET	WEIGHT
200058600	5000 PSI	200° F	1/4" FPT	.85 lb

- Ideal for dual lance applications.
- Custom make your dual lance.
- Stainless steel.
- Replaces roll-over nozzles.
- Corrosive resistant.



See in action!

<https://youtu.be/4CoQ-0h80x8>

# NOZZLES: MULTI-REG

## ST-59 MULTI-REG NOZZLES (high-low)

For use when high and low pressures are needed and switching between a solid or a flat spray pattern without changing nozzle. Low pressure mode great for introduction of downstream chemicals.

ORDER #	PRESSURE	TEMP.	ORIFICE	INLET	LENGTH	DIAMETER	WEIGHT
200059520	3200 PSI	300° F	2.0	1/4" FPT	3.75 in	1.25 in	.34 lb
200059530	3200 PSI	300° F	3.0	1/4" FPT	3.75 in	1.25 in	.34 lb
200059535	3200 PSI	300° F	3.5	1/4" FPT	3.75 in	1.25 in	.34 lb
200059540	3200 PSI	300° F	4.0	1/4" FPT	3.75 in	1.25 in	.34 lb
200059545	3200 PSI	300° F	4.5	1/4" FPT	3.75 in	1.25 in	.34 lb
200059550	3200 PSI	300° F	5.0	1/4" FPT	3.75 in	1.25 in	.34 lb
200059555	3200 PSI	300° F	5.5	1/4" FPT	3.75 in	1.25 in	.34 lb
200059560	3200 PSI	300° F	6.0	1/4" FPT	3.75 in	1.25 in	.34 lb
200059920	3000 PSI	140° F	2.0	1/4" FPT	4.25 in	1.25 in	.34 lb
200059935	3000 PSI	140° F	3.5	1/4" FPT	4.25 in	1.25 in	.34 lb

- Quick and easy spray pattern adjustment from 0° solid stream to 80° flat spray with a simple twist of the nozzle head.
- High/low feature allows for fast setting to high or low pressure mode.
- Stainless steel fins. Cover made of special heavy-duty glass-filled plastics.



#200059920



#200059935

## MULTI-REG NOZZLES

For use when high and low pressures are needed and switching between a solid or a flat spray pattern without changing nozzle. Low pressure mode great for introduction of downstream chemicals.

ORDER #	PRESSURE	TEMP.	ORIFICE /COLOR	INLET	LENGTH	DIAMETER	WEIGHT
200059630	3200 PSI	300° F	3.0 ●	1/4" FPT	3.75 in	1.25 in	.34 lb
200059635	3200 PSI	300° F	3.5 ○	1/4" FPT	3.75 in	1.25 in	.34 lb
200059640	3200 PSI	300° F	4.0 ●	1/4" FPT	3.75 in	1.25 in	.34 lb
200059645	3200 PSI	300° F	4.5 ●	1/4" FPT	3.75 in	1.25 in	.34 lb
200059650	3200 PSI	300° F	5.0 ●	1/4" FPT	3.75 in	1.25 in	.34 lb
200059655	3200 PSI	300° F	5.5 ●	1/4" FPT	3.75 in	1.25 in	.34 lb
200059660	3200 PSI	300° F	6.0 ●	1/4" FPT	3.75 in	1.25 in	.34 lb

- Quick and easy spray pattern adjustment from 0° solid stream.
- to 80° flat spray with a simple twist of the nozzle head.
- High/low feature allows for fast setting to high or low pressure mode.
- Stainless steel fins. Cover made of special heavy-duty glass-filled plastics.

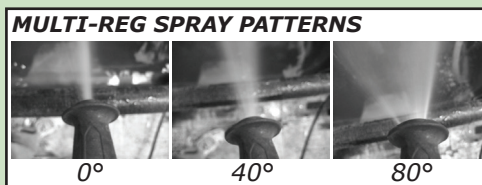

Top View

# NOZZLES: ACCESSORIES



## **TURBO NOZZLE STRAINERS** (protects turbo nozzle)

Protects from dirt or other damaging particles from entering turbo nozzles.

ORDER #	PRESSURE	TEMP.	FLOW RATE	INLET	OUTLET	WEIGHT
900000009	6000 PSI	300° F	8 GPM	1/4" QC Plug	1/4" MPT	.26 lb
900000019	6000 PSI	300° F	8 GPM	1/4" FPT	1/4" MPT	.26 lb

**Repair Kit:** #900000919

- Extends the life of your turbo nozzle.
- #900000009 threads into turbo nozzle inlet and quick connects to lance with socket.
- #900000019 threads into turbo nozzle inlet and lance outlet.
- Cleanable screen.



## **1/2" TURBO NOZZLE STRAINER** (stainless steel)

ORDER #	PRESSURE	TEMP.	FLOW RATE	INLET	OUTLET
200033870	5000 PSI	300° F	16 GPM	1/2" FPT	1/2" MPT

**Replacement screen:** #710100005

- Perfect for 1/2" turbo nozzles.
- 1/2" M x F connection.
- Protect your turbo nozzle investment.

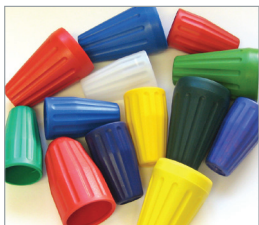

## **TURBO NOZZLE COVERS**

Minimum quantities required. Available in different colors for all Turbo Nozzles (excluding the ST-415)

## NON-ROTATING MINI SEWER NOZZLES

ORDER #	PRESSURE	O.D.	NOZZLE SIZE	REAR JETS	SIDE JETS	INLET
120000380	7252 PSI	.39"	030	3	—	1/16" F
120001380	7252 PSI	.39"	065	3	—	1/16" F
120373373	7252 PSI	.39"	065	3	3	1/16" F

- (3) rear jets for maximum thrust.
- (3) (90°) side jet option for powerful wall coverage.
- Ideal for 1/2" - 1" diameter lines.
- Stainless steel.



#120000380



#120373373

## NON-ROTATING "COMPRESSOR" SEWER NOZZLES

ORDER #	PRESSURE	O.D.	FLOW RATE	NOZZLE SIZE	FRONT JETS	REAR JETS	INLET
120155375	7252 PSI	.59"	4.5 GPM	035	1	3	1/8" F
10120045004	7252 PSI	.59"	4.5 GPM	045	—	4	1/8" F
10120045103	7252 PSI	.59"	4.5 GPM	045	1	3	1/8" F
10120055004	7252 PSI	.59"	4.5 GPM	055	—	4	1/8" F
10120055103	7252 PSI	.59"	4.5 GPM	055	1	3	1/8" F
10120080004	7252 PSI	.59"	4.5 GPM	080	—	4	1/8" F
10120080103	7252 PSI	.59"	4.5 GPM	080	1	3	1/8" F

- Compact design is ideal for maneuvering through tight elbows.
- Front port blasts through roots, solid clogs, scale and ice.
- Ideal for 1" - 3" diameter lines.
- Hardened stainless steel.



## NON-ROTATING "PREDATOR" SEWER NOZZLE

ORDER #	PRESSURE	O.D.	FLOW RATE	NOZZLE SIZE	FRONT JETS	REAR JETS	INLET
120163390	7252 PSI	.86"	6.6 GPM	045	1	3	1/4" F

- Cone shape design is ideal for maneuvering through tight bends and traps.
- Front jets for blasting through clogs.
- (3) rear jets for a maximum thrust and cleaning impact.
- Hardened stainless steel.
- Ideal for 2" - 4" diameter lines.



# NOZZLES: SEWER



## NON-ROTATING "ROOT RAM" SEWER NOZZLE

ORDER #	PRESSURE	O.D.	FLOW RATE	NOZZLE SIZE	FRONT JETS	REAR JETS	INLET
120155672	7252 PSI	.86"	7.9 GPM	055	1	6	1/4" F

- (3) rear (30°) jets and (3) rear (45°) for better drive and cleaning coverage.
- Ideal for 2" - 4" lines.
- Hardened stainless steel.



## NON-ROTATING "GREASE BALL" SEWER NOZZLE

ORDER #	PRESSURE	O.D.	NOZZLE SIZE	REAR JETS	INLET
120000860	7252 PSI	1"	080	8	1/4" F

- Designed for cleaning side wall debris and works well on roots.
- Hardened stainless steel.
- Ideal for 2" - 4" diameter lines.
- Jets are recessed for damage protection.



## NON-ROTATING "HYDRO MOLE" SEWER NOZZLE

ORDER #	PRESSURE	O.D.	NOZZLE SIZE	FRONT JETS	REAR JETS	INLET
120460385	7250 PSI	.86"	070	4	3	1/4" F

- 4 strong, concentrated forward jets for breaking through most any solid clog, including ice.
- Ideal for 2" - 4" lines.
- Nozzle jets are recessed for protection against physical impact.

#120163391



#120000675

## NON-ROTATING "NEGOTIATOR" SEWER NOZZLES

ORDER #	PRESSURE	O.D.	FLOW RATE	NOZZLE SIZE	FRONT JETS	REAR JETS	INLET
120163391	7252 PSI	.86"	7.9 GPM	050	1	3	1/4" F
120000675	7252 PSI	.86"	7.9 GPM	060	—	6	1/4" F

- Compact design, ideal for tight elbows.
- Hardened stainless steel.
- Ideal for 2" - 4" diameter lines.
- Available with 3 or 6 rear jets.
- Also available with or without front jets.

## NON-ROTATING "BALL TYPE" SEWER NOZZLES

ORDER #	PRESSURE	O.D.	NOZZLE SIZE	FRONT JETS	REAR JETS	INLET
122370000	4200 PSI	.59"	035	—	3	1/8" F
122365000	4200 PSI	.59"	040	—	3	1/8" F
122375000	4200 PSI	.59"	045	—	3	1/8" F
122390000	4200 PSI	.59"	055	—	3	1/8" F
122300000	4200 PSI	.59"	060	—	3	1/8" F
122320500	4200 PSI	.59"	090	—	3	1/8" F
122375175	4200 PSI	.59"	050	1	3	1/8" F
122370170	4200 PSI	.59"	055	1	3	1/8" F
122385185	4200 PSI	.59"	060	1	3	1/8" F
122390190	4200 PSI	.59"	065	1	3	1/8" F
122300100	4200 PSI	.59"	075	1	3	1/8" F
122320120	4200 PSI	.59"	100	1	3	1/8" F
900204012	4200 PSI	.59"	120	1	3	1/8" F
121370000	4200 PSI	.75"	035	—	3	1/4" F
121395000	4200 PSI	.75"	040	—	3	1/4" F
121380000	4200 PSI	.75"	045	—	3	1/4" F
121390000	4200 PSI	.75"	050	—	3	1/4" F
121480000	4200 PSI	.75"	055	—	4	1/4" F
121300000	4200 PSI	.75"	060	—	3	1/4" F
121312000	4200 PSI	.75"	090	—	3	1/4" F
121880000	4200 PSI	.75"	120	—	8	1/4" F
121360170	4200 PSI	.75"	040	1	3	1/4" F
121370170	4200 PSI	.75"	045	1	3	1/4" F
121375175	4200 PSI	.75"	055	1	3	1/4" F
121470170	4200 PSI	.75"	060	1	4	1/4" F
121390191	4200 PSI	.75"	065	1	3	1/4" F
121480180	4200 PSI	.75"	075	1	4	1/4" F
121395195	4200 PSI	.75"	080	1	3	1/4" F
121310000	4200 PSI	.75"	090	1	3	1/4" F
121320010	4200 PSI	.75"	100	1	3	1/4" F
121500100	4200 PSI	.75"	100	1	5	1/4" F
121320000	4200 PSI	.75"	120	1	3	1/4" F
123065184	4200 PSI	.920"	070	—	4	3/8" F
123065188	4200 PSI	.920"	040	1	3	3/8" F
123065187	4200 PSI	.920"	055	1	3	3/8" F
123065189	4200 PSI	.920"	085	1	4	3/8" F
123065186	4200 PSI	.920"	120	1	4	3/8" F
123065185	4200 PSI	.920"	140	1	4	3/8" F
123065182	4200 PSI	.920"	150	1	4	3/8" F
123065181	4200 PSI	.920"	200	1	4	3/8" F

- Nozzles with forward ports blast through and break up clogs.
- Rear ports thrust nozzle forward and flush debris.
- Great cornering ability.
- Stainless steel.
- Size stamped nozzle.



1/8" ideal for 1" - 3" lines



1/4" ideal for 2" - 4" lines



3/8" ideal for 4" - 8" lines

# NOZZLES: SEWER

## NON-ROTATING "BULLET" SEWER NOZZLES



1/4" ideal for  
2" - 4" lines



3/8" ideal for  
4" - 8" lines



Inserts  
included

ORDER #	PRESSURE	O.D.	NOZZLE SIZE	FRONT JETS	REAR JETS	INLET
649030216040	7252 PSI	.98"	040	0	6	1/4" F
649030216045	7252 PSI	.98"	045	1	6	1/4" F
649030216055	7252 PSI	.98"	055	1	6	1/4" F
649030216060	7252 PSI	.98"	060	1	6	1/4" F
649030216070	7252 PSI	.98"	070	1	6	1/4" F
649030216080	7252 PSI	.98"	080	0	6	1/4" F
649030216081	7252 PSI	.98"	080	1	6	1/4" F
649030216085	7252 PSI	.98"	085	1	6	1/4" F
649030216100	7252 PSI	.98"	100	1	6	1/4" F
649030216120	7252 PSI	.98"	120	1	6	1/4" F
649030216121	7252 PSI	.98"	120	0	6	1/4" F
649030216150	7252 PSI	.98"	150	1	6	1/4" F
649030216161	7252 PSI	.98"	160	0	6	1/4" F
649030216180	7252 PSI	.98"	180	1	6	1/4" F
649030216200	7252 PSI	.98"	200	1	6	1/4" F
649030216250	7252 PSI	.98"	250	1	6	1/4" F
649030314045	7252 PSI	1.18"	045	1	4	3/8" F
649030314050	7252 PSI	1.18"	050	1	4	3/8" F
649030314055	7252 PSI	1.18"	055	1	4	3/8" F
649030314060	7252 PSI	1.18"	060	1	4	3/8" F
649030314061	7252 PSI	1.18"	060	0	4	3/8" F
649030314065	7252 PSI	1.18"	065	1	4	3/8" F
649030314080	7252 PSI	1.18"	080	1	4	3/8" F
649030314081	7252 PSI	1.18"	080	0	4	3/8" F
649030314100	7252 PSI	1.18"	100	1	4	3/8" F
649030314101	7252 PSI	1.18"	100	0	4	3/8" F
649030314120	7252 PSI	1.18"	120	1	4	3/8" F
649030314121	7252 PSI	1.18"	120	0	4	3/8" F
649030314150	7252 PSI	1.18"	150	1	4	3/8" F
649030314200	7252 PSI	1.18"	200	1	4	3/8" F
649030316050	7252 PSI	.98"	050	1	6	3/8" F
649030316051	7252 PSI	.98"	050	0	6	3/8" F
649030316060	7252 PSI	.98"	060	1	6	3/8" F
649030316061	7252 PSI	.98"	060	0	6	3/8" F
649030316065	7252 PSI	.98"	065	1	6	3/8" F
649030316080	7252 PSI	.98"	080	1	6	3/8" F
649030316081	7252 PSI	.98"	080	0	6	3/8" F
649030316100	7252 PSI	.98"	100	1	6	3/8" F
649030316120	7252 PSI	.98"	120	1	6	3/8" F
649030316121	7252 PSI	.98"	120	0	6	3/8" F
649030316140	7252 PSI	.98"	140	1	6	3/8" F
649030316150	7252 PSI	.98"	150	1	6	3/8" F
649030316170	7252 PSI	.98"	170	1	6	3/8" F
649030316200	7252 PSI	.98"	200	1	6	3/8" F
649030316250	7252 PSI	.98"	250	1	6	3/8" F
649030316301	7252 PSI	.98"	300	0	6	3/8" F

## NON-ROTATING "BULLET" SEWER NOZZLES

*continued*

ORDER #	PRESSURE	O.D.	NOZZLE SIZE	FRONT JETS	REAR JETS	INLET
649030416041	7252 PSI	1.18"	040	1	6	1/2" F
649030416045	7252 PSI	1.18"	045	1	6	1/2" F
649040416045	7252 PSI	1.18"	045	1	6	1/2" M
649030416060	7252 PSI	1.18"	060	1	6	1/2" F
649040416060	7252 PSI	1.18"	060	1	6	1/2" M
649030416075	7252 PSI	1.18"	075	1	6	1/2" F
649040416075	7252 PSI	1.18"	075	1	6	1/2" M
649030416080	7252 PSI	1.18"	080	1	6	1/2" F
649040416080	7252 PSI	1.18"	080	1	6	1/2" M
649030416081	7252 PSI	1.18"	080	0	6	1/2" F
649030416085	7252 PSI	1.18"	085	1	6	1/2" F
649030416100	7252 PSI	1.18"	100	1	6	1/2" F
649040416100	7252 PSI	1.18"	100	1	6	1/2" M
649030416120	7252 PSI	1.18"	120	1	6	1/2" F
649040416120	7252 PSI	1.18"	120	1	6	1/2" M
649030416121	7252 PSI	1.18"	120	0	6	1/2" F
649030416140	7252 PSI	1.18"	140	1	6	1/2" F
649030416150	7252 PSI	1.18"	150	1	6	1/2" F
649040416150	7252 PSI	1.18"	150	1	6	1/2" M
649030416151	7252 PSI	1.18"	150	0	6	1/2" F
649030416180	7252 PSI	1.18"	180	1	6	1/2" F
649030416181	7252 PSI	1.18"	180	0	6	1/2" F
649030416200	7252 PSI	1.18"	200	1	6	1/2" F
649040416200	7252 PSI	1.18"	200	1	6	1/2" M
649030416201	7252 PSI	1.18"	200	0	6	1/2" F
649030415280	7252 PSI	1.18"	280	0	6	1/2" F
649030416280	7252 PSI	1.18"	280	1	6	1/2" F
649030416355	7252 PSI	1.18"	355	0	6	1/2" F
649030416615	7252 PSI	1.18"	615	1	6	1/2" F
652200040400	7252 PSI	2.76"	400	0	6	3/4" F
652200040401	7252 PSI	2.76"	400	1	6	3/4" F
652200040450	7252 PSI	2.76"	450	1	6	3/4" F
652200030470	7252 PSI	2.76"	470	1	6	3/4" F
652200040470	7252 PSI	2.76"	470	0	6	3/4" F
652200030615	7252 PSI	2.76"	615	1	6	3/4" F
652200060230	7252 PSI	2.95"	230	1	8	1" F
652200060650	7252 PSI	2.95"	650	1	8	1" F
652200050750	7252 PSI	2.95"	700	0	8	1" F
652200060750	7252 PSI	2.95"	750	1	8	1" F
652200060790	7252 PSI	2.95"	790	1	8	1" F

- Made of wear resistant stainless steel.
- Available with or without front jets.
- Sturdy wall thickness.
- All ports are hardened stainless steel inserts, precisely drilled for efficiency.
- Ideal for blasting through frozen clogs and removing sludge and silt.



1/2" ideal for 6"-12" lines



3/4" ideal for 12"-20" lines



1" ideal for 20"-28" lines



Inserts included

# NOZZLES: SEWER



1/4" ideal for 2" - 4" lines  
 3/8" ideal for 4" - 8" lines  
 1/2" ideal for 6" - 12" lines  
 3/4" ideal for 12" - 20" lines

## WARHEAD RADIAL NOZZLES

ORDER #	PRESSURE	NOZZLE SIZE	FRONT JETS	SIDE JETS	REAR JETS	INLET
649110219065	7250 PSI	065	1	6	3	1/4" F
649110219080	7250 PSI	080	1	6	3	1/4" F
649110219100	7250 PSI	100	1	6	3	1/4" F
649110219120	7250 PSI	120	1	6	3	1/4" F
649110219150	7250 PSI	150	1	6	3	1/4" F
649110219200	7250 PSI	200	1	6	3	1/4" F
649110319065	7250 PSI	065	1	6	3	3/8" F
649110319080	7250 PSI	080	1	6	3	3/8" F
649110319100	7250 PSI	100	1	6	3	3/8" F
649110319120	7250 PSI	120	1	6	3	3/8" F
649110319150	7250 PSI	150	1	6	3	3/8" F
649110319200	7250 PSI	200	1	6	3	3/8" F
649110419080	7250 PSI	080	1	6	3	1/2" F
649110419100	7250 PSI	100	1	6	3	1/2" F
649110419120	7250 PSI	120	1	6	3	1/2" F
649110419150	7250 PSI	150	1	6	3	1/2" F
649110419200	7250 PSI	200	1	6	3	1/2" F
649110419250	7250 PSI	250	1	6	3	1/2" F
649110519100	7250 PSI	100	1	6	3	3/4" F
649110519450	7250 PSI	450	1	6	3	3/4" F

- Made of wear resistant hardened stainless steel.
- All ports are hardened stainless steel for efficiency.
- Improved sidewall cleaning.
- Great for sanitary applications.
- Ideal for removing hard grease and scale.



1/4" ideal for 2" - 4" lines  
 3/8" ideal for 4" - 8" lines

## WARHEAD NOZZLES

ORDER #	PRESSURE	NOZZLE SIZE	FRONT JETS	REAR JETS	INLET
649120216065	7250 PSI	065	1	6	1/4" F
649120216080	7250 PSI	080	1	6	1/4" F
649120216100	7250 PSI	100	1	6	1/4" F
649120216120	7250 PSI	120	1	6	1/4" F
649120216150	7250 PSI	150	1	6	1/4" F
649120216200	7250 PSI	200	1	6	1/4" F
649120316040	7250 PSI	040	1	6	3/8" F
649120316065	7250 PSI	065	1	6	3/8" F
649120316080	7250 PSI	080	1	6	3/8" F
649120316100	7250 PSI	100	1	6	3/8" F
649120316120	7250 PSI	120	1	6	3/8" F
649120316150	7250 PSI	150	1	6	3/8" F
649120316200	7250 PSI	200	1	6	3/8" F

- Made of wear resistant hardened stainless steel.
- All ports are hardened stainless steel for efficiency.
- Great for sanitary applications.
- Ideal for removing hard grease and scale.

## WARHEAD NOZZLES

ORDER #	PRESSURE	NOZZLE SIZE	FRONT JETS	REAR JETS	INLET
649120416080	7250 PSI	080	1	6	1/2" F
649120416100	7250 PSI	100	1	6	1/2" F
649120416120	7250 PSI	120	1	6	1/2" F
649120416150	7250 PSI	150	1	6	1/2" F
649120416200	7250 PSI	200	1	6	1/2" F
649120416250	7250 PSI	250	1	6	1/2" F
649120618100	7250 PSI	100	1	8	1" F

- Made of wear resistant hardened stainless steel.
- All ports are hardened stainless steel for efficiency.
- Great for sanitary applications.
- Ideal for removing hard grease and scale.



1/2" ideal for 6" - 12" lines  
1" ideal for 20" - 28" lines

## VIBRATING ROTATING NOZZLES

ORDER #	PRESSURE	NOZZLE SIZE	O.D.	REAR JETS	SIDE JETS	INLET
200049671060	3625 PSI	060	1.18"	4	3	1/4" F
200049671080	3625 PSI	080	1.18"	4	3	1/4" F
200049671090	3625 PSI	090	1.18"	4	3	1/4" F
200049671105	3625 PSI	105	1.18"	4	3	1/4" F
200049671625	3625 PSI	625	1.18"	4	3	1/4" F
200049676090	3625 PSI	060	1.18"	4	3	3/8" F
200049676090	3625 PSI	090	1.18"	4	3	3/8" F
200049676100	3625 PSI	100	1.18"	4	3	3/8" F
200049676130	3625 PSI	130	1.18"	4	3	3/8" F
200049676140	3625 PSI	140	1.18"	4	3	3/8" F
200049681070	3625 PSI	070	1.50"	5	3	1/2" F
200049681100	3625 PSI	100	1.50"	5	3	1/2" F
200049681110	3625 PSI	110	1.50"	5	3	1/2" F
200049681120	3625 PSI	120	1.50"	5	3	1/2" F
200049681150	3625 PSI	150	1.50"	5	3	1/2" F
200049681160	3625 PSI	160	1.50"	5	3	1/2" F
200049681180	3625 PSI	180	1.50"	5	3	1/2" F
200049681200	3625 PSI	200	1.50"	5	3	1/2" F
200049681250	3625 PSI	250	1.50"	5	3	1/2" F
200049686636	3625 PSI	360	1.50"	6	3	3/4" F
200049686680	3625 PSI	680	1.50"	6	3	3/4" F

- Stainless steel and brass construction.



# NOZZLES: SEWER



#200049950

## ST-49 ROTATING SEWER NOZZLES

ORDER #	PRESSURE	O.D.	FLOW RATE	NOZZLE SIZE	REAR JETS	SIDE JETS	INLET
200049950	7252 PSI	.47"	6.6 GPM	050	2	2	1/8" FBSP
200049970	7252 PSI	.47"	9.2 GPM	070	2	2	1/8" FBSP
200049951	7252 PSI	.47"	6.6 GPM	050	2	2	1/8" FPT
200049971	7252 PSI	.47"	9.2 GPM	070	2	2	1/8" FPT

- Hardened stainless steel.
- Excellent interior cleaning nozzle.
- Slower rotor speed for higher cleaning performance.
- Ideal for cleaning heat exchange tubes.

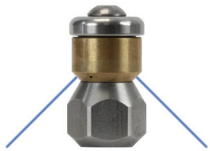
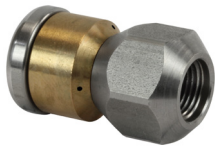

## ST-49 ROTATING SEWER NOZZLES

ORDER #	PRESSURE	O.D.	NOZZLE SIZE	FRONT JETS	REAR JETS	SIDE JETS	INLET
200049825	4000 PSI	.74"	045	None	3	None	1/8" F
200049830	4000 PSI	.74"	050	None	3	None	1/8" F
200049650	4000 PSI	.74"	055	None	3	None	1/8" F
200049840	4000 PSI	.74"	060	None	3	None	1/8" F
200049845	4000 PSI	.74"	070	None	3	None	1/8" F
200049850	4000 PSI	.74"	080	None	3	None	1/8" F
200049794	4000 PSI	.74"	040	None	3	None	1/4" F
200049795	4000 PSI	.74"	045	None	3	None	1/4" F
200049800	4000 PSI	.74"	050	None	3	None	1/4" F
200049600	4000 PSI	.74"	055	None	3	None	1/4" F
200049810	4000 PSI	.74"	060	None	3	None	1/4" F
200049815	4000 PSI	.74"	070	None	3	None	1/4" F
200049610	4000 PSI	.74"	080	None	3	None	1/4" F
200049700	4000 PSI	.74"	055	None	None	2	1/4" F
200065161	4000 PSI	.74"	090	None	3	2	1/4" F
200065162	4000 PSI	.74"	120	3	3	2	1/4" F
200049860	4000 PSI	.94"	040	None	3	None	3/8" F
200049870	4000 PSI	.94"	045	None	3	None	3/8" F
200049880	4000 PSI	.94"	050	None	3	None	3/8" F
200049890	4000 PSI	.94"	060	None	3	None	3/8" F
200049885	4001 PSI	.94"	065	None	3	None	3/8" F
200049891	4000 PSI	.94"	080	None	3	None	3/8" F
200049892	4000 PSI	.94"	100	None	3	None	3/8" F
200049893	4000 PSI	.94"	120	None	3	None	3/8" F
200049894	4000 PSI	.94"	150	None	3	None	3/8" F
200049895	4000 PSI	.94"	200	None	4	None	3/8" F
200049896	4000 PSI	.94"	100	1	3	None	3/8" F
200049897	4000 PSI	.94"	120	1	3	None	3/8" F
200049898	4000 PSI	.94"	150	1	3	None	3/8" F
200049899	4000 PSI	.94"	180	1	3	None	3/8" F

- Brass and stainless construction.
- Ideal for cleaning or flushing pipes.
- Size stamped on nozzle.
- 1/8" ideal for 1"-3" lines.
- 1/4" ideal for 2"-4" lines.
- 3/8" ideal for 4"-8" lines.



See in action!

<https://www.youtube.com/watch?v=e1guuP1ErWw>

## NON-ROTATING "MILLING" SEWER NOZZLES

ORDER #	PRESSURE	O.D.	NOZZLE SIZE	FRONT JETS	REAR JETS	INLET
649010234040	5076 PSI	.95"	040	3	4	1/4" F
649010234045	5076 PSI	.95"	045	3	4	1/4" F
649010234050	5076 PSI	.95"	050	3	4	1/4" F
649010234055	5076 PSI	.95"	055	3	4	1/4" F
649010244060	5076 PSI	.95"	060	4	4	1/4" F
649010244061	5076 PSI	.95"	060	3	4	1/4" F
649010244070	5076 PSI	.95"	070	4	4	1/4" F
649010244080	5076 PSI	.95"	080	4	4	1/4" F
649010244081	5076 PSI	.95"	080	3	4	1/4" F
649010244085	5076 PSI	.95"	085	4	4	1/4" F
649010244100	5076 PSI	.95"	100	4	4	1/4" F
649010244101	5076 PSI	.95"	100	3	4	1/4" F
649010244120	5076 PSI	.95"	120	4	4	1/4" F
649010244150	5076 PSI	.95"	150	4	4	1/4" F
649010244200	5076 PSI	.95"	200	4	4	1/4" F
649010336055	5076 PSI	1.11"	055	3	6	3/8" F
649010346070	5076 PSI	1.11"	070	4	6	3/8" F
649010346071	5076 PSI	1.11"	070	3	6	3/8" F
649010346080	5076 PSI	1.11"	080	4	6	3/8" F
649010346081	5076 PSI	1.11"	080	3	6	3/8" F
649010346085	5076 PSI	1.11"	085	3	6	3/8" F
649010346090	5076 PSI	1.11"	090	4	6	3/8" F
649010346100	5076 PSI	1.11"	100	4	6	3/8" F
649010346101	5076 PSI	1.11"	100	3	6	3/8" F
649010346120	5076 PSI	1.11"	120	4	6	3/8" F
649010346150	5076 PSI	1.11"	150	4	6	3/8" F
649010346200	5076 PSI	1.11"	200	4	6	3/8" F
649010346250	5076 PSI	1.11"	250	4	6	3/8" F
649010346270	5076 PSI	1.11"	270	4	6	3/8" F
649010446070	5076 PSI	1.23"	070	3	6	1/2" F
649010446075	5076 PSI	1.23"	075	4	6	1/2" F
649010446080	5076 PSI	1.23"	080	4	6	1/2" F
649010446081	5076 PSI	1.23"	080	3	6	1/2" F
649010446100	5076 PSI	1.23"	100	4	6	1/2" F
649010446120	5076 PSI	1.23"	120	4	6	1/2" F
649010446150	5076 PSI	1.23"	150	4	6	1/2" F
649010446180	5076 PSI	1.23"	180	4	6	1/2" F
649010446200	5076 PSI	1.23"	200	4	6	1/2" F
649010446201	5076 PSI	1.23"	200	3	6	1/2" F
649010446250	5076 PSI	1.23"	250	4	6	1/2" F
649010446310	5076 PSI	1.23"	310	4	6	1/2" F
649010446311	5076 PSI	1.23"	310	3	6	1/2" F
649010446495	5076 PSI	1.23"	495	4	6	1/2" F

- Sharp cutting edges and forward tearing jets tear through almost any clog.
- Ports are hardened stainless steel insert type with precision port.
- Works well for lines with roots.
- Hardened stainless steel body.

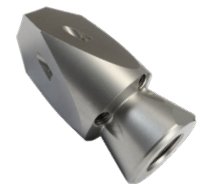

# NOZZLES: SEWER



3/4" ideal for 12" - 20" lines



1" ideal for 20" - 28" lines

## NON-ROTATING "MILLING" SEWER NOZZLES

*continued*

ORDER #	PRESSURE	O.D.	NOZZLE SIZE	FRONT JETS	REAR JETS	INLET
652300040400	5076 PSI	1.50"	400	3	6	3/4" F
652300040401	5076 PSI	1.50"	400	4	6	3/4" F
652300040450	5076 PSI	1.50"	450	4	6	3/4" F
652300040580	5076 PSI	1.50"	580	4	6	3/4" F
652300040680	5076 PSI	1.50"	680	4	6	3/4" F
652300050750	5076 PSI	1.96"	750	3 or 4	9	1" F

- Sharp cutting edges and forward tearing jets tear through almost any clog.
- Ports are hardened stainless steel insert type with precision port.
- Works well for lines with roots.
- Hardened stainless steel body.

## SEWER JETTING TURBO NOZZLES

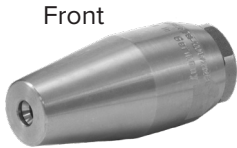

Front



Rear

#200358681

ORDER #	PRESSURE	TEMP.	ORIFICE	FRONT JETS	REAR JETS	INLET	WEIGHT
200358651	5070 PSI	212° F	5.0	1	5	1/4" F	.61 lb
200358661	5070 PSI	212° F	6.0	1	6	1/4" F	.61 lb
200358681	5070 PSI	212° F	8.0	1	8	1/4" F	.61 lb

- Precision drilled rear drive jets.
- All stainless steel construction.
- Great nozzle for cutting, cleaning and removal.



## DUAL TURBO NOZZLE DRIVER

ORDER #	PRESSURE	O.D.	OUTLET	INLET
200049410	3625 PSI	3.46"	2 x 1/4" M	3/8" F

- Use with Suttner turbo nozzles.
- Brass body with stainless steel male 1/4" connections.
- Excellent choice for flushing silt and debris from sewer main lines.



shown here with turbo nozzles (not included)

## DUAL MEG NOZZLE DRIVER

ORDER #	PRESSURE	O.D.	OUTLET	INLET
010000399	6000 PSI	2.83"	2 x 1/4" FPT	1/2" F

- Use with (2) rear facing fan jet meg nozzles.
- Brass body.
- Great choice for flushing sewer mainlines.



shown with here  
Meg nozzles  
(not included)

## SINGLE TURBO NOZZLE DRIVER

ORDER #	PRESSURE	O.D.	OUTLET	INLET
200049400	5800 PSI	2.0625"	1/4" M	1/4" F

- Use with Suttner turbo nozzles.
- Hardened stainless steel.
- Fine choice for cutting and flushing roots.



Shown here with  
Turbo nozzle  
(not included)



## TURBO NOZZLE DRIVERS

ORDER #	PRESSURE	O.D.	NOZZLE SIZE	INLET	TURBO NOZZLE
6490812060651	5076 PSI	1.13"	065	1/4" F	ST-357
6490812060801	5076 PSI	1.13"	080	1/4" F	ST-357
6490813060651	5076 PSI	1.19"	065	3/8" F	ST-357
6490813060801	5076 PSI	1.19"	080	3/8" F	ST-357
6490813060901	5076 PSI	1.19"	090	3/8" F	ST-357
6490814060101	5076 PSI	1.19"	100	3/8" F	ST-357
6490813061201	5076 PSI	1.19"	120	3/8" F	ST-357
6490812060652	5076 PSI	1.13"	065	1/4" F	ST-456
6490812060802	5076 PSI	1.13"	080	1/4" F	ST-456
6490813060652	5076 PSI	1.19"	065	3/8" F	ST-456
6490813060802	5076 PSI	1.19"	080	3/8" F	ST-456
6490813060902	5076 PSI	1.19"	090	3/8" F	ST-456
6490814060102	5076 PSI	1.19"	100	3/8" F	ST-456
6490813061202	5076 PSI	1.19"	120	3/8" F	ST-456
6490823064801	6000 PSI	1.19"	480	3/8" F	ST-457
6490824060651	6000 PSI	1.44"	065	1/2" F	ST-457
6490824061001	6000 PSI	1.44"	100	1/2" F	ST-457
6490824061151	6000 PSI	1.44"	110	1/2" F	ST-457
6490824061201	6000 PSI	1.44"	120	1/2" F	ST-457
6490824061501	6000 PSI	1.44"	150	1/2" F	ST-457
6490824061701	6000 PSI	1.44"	170	1/2" F	ST-457
6490824061801	6000 PSI	1.44"	180	1/2" F	ST-457
6490824062001	6000 PSI	1.44"	200	1/2" F	ST-457
6490824062501	6000 PSI	1.44"	250	1/2" F	ST-457
6490824063001	6000 PSI	1.44"	300	1/2" F	ST-457

FRONT JETS	REAR JETS
1	6

- Stainless steel turbo nozzle driver.
- Ideal for thrusting turbo nozzles into sewer lines for root cutting and forward sidewall blasting.

**Each part number includes the body, inserts, and turbo nozzle.**

**\*Disclaimer: Turbo Nozzle Drivers are NOT sold separately.  
Must use with Suttner turbo nozzle.**



Inserts  
included



1/4"



3/8" and 1/2"



Shown here  
with turbo nozzle

# HOSES

**PRIVATE LABEL HOSE: 75**

**WATER SUPPLY HOSES: 76**

**CONSUMER HOSES: 77**

**PRESSURE WASHER HOSES: 79**

**CARPET HOSES: 84**

**HOSE ACCESSORIES: 85**

**SEWER HOSES: 87**

**SEWER ACCESSORIES: 90**



## GET YOUR COMPANY NOTICED

### PROMOTE YOUR COMPANY NAME OR LOGO WITH A PRIVATE HOSE

**COMPANY NAME**



**& INFORMATION HERE**



**Actual font size on layline: Arial Black, 16 pt.**

#### **Layline Options:**

- Colored background with one color text or logo
- One color text or logo

- Available on all of Suttner's high pressure hose, bulk reels and assemblies, except the SST hose.
- Minimum order is **10,000 feet per hose style.**
  - Example: Order (50) of 100 ft. assemblies **and** (100) of 50 ft. assemblies to total 10,000.
- Available in all standard hose colors. Full line of two piece crimp fittings available.
- Designed for commercial pressure washing applications.
- Available in 3000, 4000, & 6000 PSI hoses.
- Available in 1/4", 3/8", and 1/2" hoses.
- Temperature: -15° F to 250° F.
- Chemical and heat resistant rubber inner tube.
- Synthetic rubber cover.



# HOSES: WATER SUPPLY



## **WATER SUPPLY HOSES**

<b>ORDER #</b>	<b>I.D.</b>	<b>O.D.</b>	<b>LENGTH</b>	<b>WEIGHT</b>	<b>BOX QTY</b>
B3V25050	5/8"	.88"	50 ft	17.0 lb	4
B3V23050	3/4"	1.125"	50 ft	20.4 lb	3
B3V23100	3/4"	1.125"	100 ft	40.0 lb	2
B3V23150	3/4"	1.125"	150 ft	61.0 lb	1

<b>PRESSURE</b>	<b>TEMP.</b>	<b>FITTINGS</b>
200 PSI	200° F	3/4 MGHT x 3/4 FGHT

- Black bend guard on female end.
- EPDM tube and cover.
- Textile cord reinforced.
- Resistant to heat, sunlight, ozone and weathering.
- Excellent abrasion resistance.
- Crimped on, crush resistant brass garden hose connections.
- Designed specifically for supply water to pressure washer inlet.



**SUTTNER SUPERBALLS  
SEE PAGE 86**

## CONSUMER HOSES

Perfect hose for consumer/DIY pressure washers.

ORDER #	PRESSURE	FITTINGS	LENGTH	WEIGHT	BOX QTY
080032008	3200 PSI	M22 x M22	25 ft	2 lb	16
080032010	3000 PSI	1/4" FBSP Swivel Nut x M22	25 ft	2 lb	16
080032015	3000 PSI	3/8" M x M22 Screw Coupling	50 ft	3.26 lb	10
080032020	3200 PSI	M22 x M22	50 ft	3.26 lb	10

TEMP.	I.D.	O.D.
140° F	1/4"	.44"

- Designed for cold water consumer gas and electric pressure washers.
- Reinforced with one layer of polyester braid.
- Smooth thermo plastic non-marking cover.
- Resistant to cleaning detergents.



M22 x M22



3/8" Male x M22



1/4" FBSP Swivel x M22

## 5/16" SINGLE WIRE 4000 PSI HOSES

ORDER #	FITTINGS	LENGTH	WEIGHT	BOX QTY
B3V45025	3/8" MPT x M swivel	25 ft	4 lb	10
B3V45026	M22 x 3/8" M swivel	25 ft	4 lb	7
B3V45035	M22 x M22	25 ft	4 lb	10
B3V45040	3/8" QC Socket/Plug	25 ft	4 lb	10
B3V45050	3/8" MPT x M swivel	50 ft	9 lb	5
B3V45075	M22 x M22	50 ft	8 lb	5

PRESSURE	TEMP.	I.D.	O.D.
4000 PSI	-15° F to 250° F	5/16"	.65"

- Reinforced with one layer of high tensile steel wire.
- Heat resistant synthetic rubber inner tube.
- Wrapped abrasion resistant synthetic cover.
- Suitable for consumer and commercial pressure washers.
- Black bend guards on each end.
- Lighter weight wire braided rubber alternative.



3/8" QC Socket/Plug



M22 x 3/8" M swivel



M22 x M22



3/8" MPT x M swivel

## REPAIR YOUR OWN HOSE (fittings & ferrules)

Note: each fitting requires a crimp ferrule.

ORDER #	DESCRIPTION	SIZE	WEIGHT	COLOR	BOX QTY
B3R45050	Bulk Hose	500 ft reel	89 lb	Black	1
899400016	Zinc Crimp Ferrule	16.3 mm ± 0.3 mm	—	—	25
898400616	Zinc Fitting	3/8" MPT x Barb	2.8 oz	—	25
898400618	Zinc Fitting	3/8" MPT x Barb Swivel	3.8 oz	—	25
898400622	Brass/Plated Steel	M22	3.8 oz	—	25
080030816	Rubber Bend Restrictors	For 5/16" Hose	—	Black	25



# HOSES: CONSUMER

## 5/16" DOUBLE WIRE 6000 PSI BULK REEL HOSES



3/8" MPT x M Swivel

ORDER #	FITTINGS	LENGTH	WEIGHT	COLOR
B3R45105	M22 x M22	500 ft	122 lb	Black
B3R45106	3/8" MPT x M Swivel	656 ft	159 lb	Gray
PRESSURE		TEMP.	I.D.	O.D.
6000 PSI		-15° F to 250° F	5/16"	.672"

- Double wire braided rubber hose.
- Heat resistant synthetic rubber inner tube.
- Suitable for consumer and commercial pressure washers.
- Lighter weight wire braided rubber alternative.
- Wrapped abrasion resistant synthetic cover.

### REPAIR YOUR OWN HOSE (fittings & ferrules)

Note: each fitting requires a crimp ferrule.



ORDER #	DESCRIPTION	SIZE	WEIGHT	COLOR	BOX QTY
899600016	Zinc Crimp Ferrule	17.9 mm ± 0.3 mm	—	—	25
898400616	Zinc Fitting	3/8" MPT x Barb	2.8 oz	—	25
898400618	Zinc Fitting	3/8" MPT x Barb Swivel	3.8 oz	—	25
898400622	Brass/Plated Steel	M22	3.8 oz	—	25
080030817	Rubber Bend Restrictors	For 5/16" Hose	—	Red	25



## SEWER HOSE & ACCESSORIES SEE PAGES 87 THROUGH 90

# HOSES: PRESSURE WASHER

## 3/8" SINGLE WIRE 4000 PSI HOSES

ORDER #	COLOR	FITTINGS	LENGTH	WEIGHT	BOX QTY
B3V00340	Black	3/8" MPT x M Swivel	25 ft	5 lb	6
B3V00350	Black	3/8" MPT x M Swivel	50 ft	9 lb	5
B3V00351	Black	3/8" QC Socket/Plug	50 ft	9.85 lb	5
B3V00352	Gray	3/8" MPT x M Swivel	50 ft	9 lb	5
B3V00353	Gray	3/8" QC Socket/Plug	50 ft	9.85 lb	5
B3V00354	Blue	3/8" MPT x M Swivel	50 ft	9 lb	5
B3V00355	Yellow	3/8" MPT x M Swivel	50 ft	9 lb	5
B3V00375	Black	3/8" MPT x M Swivel	75 ft	14 lb	3
B3V00377	Blue	3/8" MPT x M Swivel	75 ft	14 lb	3
B3V00378	Yellow	3/8" MPT x M Swivel	75 ft	14 lb	3
B3V00380	Black	3/8" MPT x M Swivel	100 ft	18.5 lb	3
B3V00381	Black	3/8" QC Socket/Plug	100 ft	17 lb	3
B3V00382	Gray	3/8" MPT x M Swivel	100 ft	18.5 lb	3
B3V00384	Blue	3/8" MPT x M Swivel	100 ft	18.5 lb	3
B3V00700	Yellow	3/8" MPT x M Swivel	100 ft	18.5 lb	3
B3V00390	Black	3/8" MPT x M Swivel	150 ft	25 lb	2
B3V00391	Gray	3/8" MPT x M Swivel	150 ft	25 lb	2
B3V00395	Black	3/8" MPT x M Swivel	200 ft	35.5 lb	1
B3V00396	Gray	3/8" MPT x M Swivel	200 ft	35.5 lb	1

PRESSURE	TEMP.	I.D.	O.D.
4000 PSI	-15° F to 250° F	3/8"	.693"

- Synthetic rubber abrasion resistant wrapped cover.
- Designed for commercial high pressure cleaning applications.
- Single wire braided rubber hose.
- Black bend guards on each end.
- Heat resistant synthetic rubber inner tube.

### REPAIR YOUR OWN HOSE (fittings & ferrules)

Note: each fitting requires a crimp ferrule.

ORDER #	DESCRIPTION	SIZE	WEIGHT	COLOR	BOX QTY
B3R00351	Bulk Hose	500 ft reel	97.5 lb	Black	1
B3R00353	Bulk Hose	500 ft reel	97.5 lb	Gray	1
B3R00354	Bulk Hose	500 ft reel	97.5 lb	Blue	1
B3R00355	Bulk Hose	500 ft reel	97.5 lb	Yellow	1
899400038	Zinc Crimp Ferrule	18.9 mm ± 0.3 mm	—	—	25
898400738	Zinc Fitting	3/8" MPT x Barb	3.0 oz	—	25
898400739	Zinc Fitting	3/8" MPT x Barb swivel	3.5 oz	—	25
080030838	Rubber Bend Restrictors	For 3/8" Hose	—	Black	25



# HOSES: PRESSURE WASHER



#B3R00420



#B3R00430

## 3/8" SINGLE WIRE 4000 PSI SMOOTH HOSES

ORDER #	COLOR	FITTINGS	LENGTH	WEIGHT	BOX QTY
B3V00325	Black	3/8" MPT x M swivel	25 ft	5 lb	6
B3V00326	Blue	3/8" MPT x M swivel	25 ft	5 lb	6
B3V00334	Black	3/8" MPT x M swivel	50 ft	9 lb	5
B3V00335	Blue	3/8" MPT x M swivel	50 ft	9 lb	5
B3V00424	Black	3/8" MPT x M swivel	75 ft	14 lb	3
B3V00534	Black	3/8" MPT x M swivel	100 ft	19 lb	3
B3V00547	Blue	3/8" MPT x M swivel	100 ft	19 lb	3
B3V00536	Black	3/8" MPT x M swivel	150 ft	27 lb	1
B3R00420	Blue	3/8" MPT x M swivel	200 ft	47 lb	1
B3R00430	Blue	3/8" MPT x M swivel	300 ft	64 lb	1

TEMP.	PRESSURE	I.D.	O.D.
-15° F to 250° F	4000 PSI	3/8"	.693"

- Blue minimal marking abrasion resistant smooth synthetic rubber cover.
- Black bend guards on each end.
- Reinforced with one layer of high tensile steel wire.
- Heat resistant synthetic rubber inner tube.
- Designed as a solution hose for carpet cleaning equipment and high pressure cleaning applications.

## REPAIR YOUR OWN HOSE (fittings & ferrules)

Note: each fitting requires a crimp ferrule.

ORDER #	DESCRIPTION	SIZE	WEIGHT	COLOR	BOX QTY
B3R00334	Bulk Hose	500 ft reel	101 lb	Black	1
B3R00436	Bulk Hose	500 ft reel	101 lb	Blue	1
B3R00440	Bulk Hose	500 ft reel	101 lb	Yellow	1
B3R00442	Bulk Hose	500 ft reel	101 lb	Gray	1
899400038	Zinc Crimp Ferrule	18.9 mm ± 0.3 mm	—	—	25
898400738	Zinc Fitting	3/8" MPT x Barb	3.0 oz	—	25
898400739	Zinc Fitting	3/8" MPT x Barb swivel	3.5 oz	—	25
080030838	Rubber Bend Restrictors	For 3/8" Hose	—	Black	25

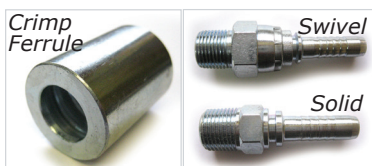

# HOSES: PRESSURE WASHER

## 3/8" SINGLE WIRE 4000 PSI "JUMPER" HOSES

ORDER #	FITTINGS	LENGTH	WEIGHT	BOX QTY
B3V00018	3/8" MPT x M swivel	18 in	.6 lb	50
B3V00002	3/8" MPT x M swivel	2 ft	.75 lb	50
B3V00003	3/8" MPT x M swivel	3 ft	1.05 lb	50
B3V00004	3/8" MPT x M swivel	4 ft	1.05 lb	50
B3V00007	3/8" MPT x M swivel	5 ft	1.25 lb	30
B3V00006	3/8" MPT x M swivel	6 ft	1.40 lb	30
B3V00011	3/8" MPT x M swivel	11 ft	2.25 lb	20
B3V00012	3/8" MPT x M swivel	12 ft	2.5 lb	20
B3V00318	3/8" MPT x M swivel	18 ft	3.7 lb	10

TEMP.	PRESSURE	I.D.	O.D.
-15° F to 250° F	4000 PSI	3/8"	.693"

- Synthetic rubber abrasion resistant wrapped cover.
- Designed for connecting hose reels to pressure washers.
- Heat resistant synthetic rubber inner tube.
- Commercial grade.
- Reinforced with one layer of high tensile steel wire.



## 3/8" SUPER TUFF COVER HOSES

*This hose has an additional, more durable coating that makes it more abrasion resistant, non marking and Super Tuff cover that lasts longer than the standard hose.*

ORDER #	PRESSURE	O.D.	LENGTH	WEIGHT	BOX QTY
B3V46050	4000 PSI	.693"	50 ft	9.0 lb	5
B3V46100	4000 PSI	.693"	100 ft	19.0 lb	3
B3V47050	6000 PSI	.74"	50 ft	15.0 lb	5
B3V47100	6000 PSI	.74"	100 ft	30.0 lb	2

TEMP.	I.D.	FITTINGS
-15° F to 250° F	3/8"	3/8" MPT x M swivel

- Reduce downtime because of a worn out hose.
- Reinforced with one layer (4000 PSI) or 2 layers (6000 PSI) of high tensile steel wire.
- Designed for high pressure cleaning applications that require exceptional cover wear resistant.
- Heat resistant synthetic rubber inner tube.
- Red bend guards on each end.



# HOSES: PRESSURE WASHER

## 3/8" DOUBLE WIRE 6000 PSI "JUMPER" HOSES



ORDER #	FITTINGS	LENGTH	WEIGHT	BOX QTY
B3V58018	3/8" MPT x M swivel	18 in	.8 lb	50
B3V58002	3/8" MPT x M swivel	2 ft	1.0 lb	50
B3V58019	3/8" MPT x M swivel	2.5 ft	1.2 lb	50
B3V58003	3/8" MPT x M swivel	3 ft	1.25 lb	50
B3V58004	3/8" MPT x M swivel	4 ft	1.55 lb	50
B3V58006	3/8" MPT x M swivel	6 ft	2.10 lb	15
B3V58010	3/8" MPT x M swivel	10 ft	3.25 lb	10
B3V58015	3/8" MPT x M swivel	15 ft	4.55 lb	10

TEMP.	PRESSURE	I.D.	O.D.
-15° F to 250° F	6000 PSI	3/8"	.77"

- Double wire braided rubber hose.
- Synthetic rubber abrasion resistant wrapped cover.
- Designed for connecting hose reels to pressure washers.
- Reinforced with one layer of high tensile steel wire.
- Heat resistant synthetic rubber inner tube.
- Commercial grade.

## 3/8" DOUBLE WIRE 6000 PSI HOSES



ORDER #	FITTINGS	LENGTH	WEIGHT	COLOR	BOX QTY
B3V58025	3/8" MPT x M swivel	25 ft	8 lb	Black	6
B3V58050	3/8" MPT x M swivel	50 ft	15 lb	Black	5
B3V58060	3/8" MPT x M swivel	50 ft	15 lb	Gray	5
B3V58075	3/8" MPT x M swivel	75 ft	23 lb	Black	3
B3V58100	3/8" MPT x M swivel	100 ft	30 lb	Black	2
B3V58101	3/8" MPT x M swivel	100 ft	30 lb	Gray	2
B3V58150	3/8" MPT x M swivel	150 ft	41 lb	Gray	2
B3V58200	3/8" MPT x M swivel	200 ft	57 lb	Gray	1

TEMP.	PRESSURE	I.D.	O.D.
-15° F to 250° F	6000 PSI	3/8"	.77"

- Bend guards on each end.
- Heat resistant synthetic rubber inner tube.
- Designed for high pressure cleaning applications.
- Abrasion resistant wrapped synthetic rubber cover.
- Double wire braided rubber hose.
- An ideal hose for hot water applications.

## REPAIR YOUR OWN HOSE (fittings & ferrules)

**Note:** each fitting requires a crimp ferrule.



ORDER #	DESCRIPTION	SIZE	WEIGHT	COLOR	BOX QTY
B3R58050	Bulk Hose	500 ft reel	153 lb	Black	1
B3R58060	Bulk Hose	500 ft reel	153 lb	Gray	1
899600038	Zinc Crimp Ferrule	20.6 mm ± 0.3 mm	—	—	25
898400738	Zinc Fitting	3/8" MPT x Barb	3.0 oz	—	25
898400739	Zinc Fitting	3/8" MPT x Barb swivel	3.5 oz	—	25
898400722	Brass/Plated Steel	M22	3.8 oz	—	25
080030839	Rubber Bend Restrictors	for 3/8" Hose	—	Red	25

# HOSES: PRESSURE WASHER

## 3/8" 7200 PSI "ULTRA HIGH" PRESSURE HOSE

ORDER #	FITTINGS	LENGTH	WEIGHT	BOX QTY
B3V72003	3/8" MPT x MPT	3 ft	1.45 lb	25
B3V72004	3/8" MPT x MPT	4 ft	1.50 lb	25
B3V72050	3/8" MPT x MPT	50 ft	14.0 lb	4
B3V72100	3/8" MPT x MPT	100 ft	27.0 lb	2
B3V72150	3/8" MPT x MPT	150 ft	42.0 lb	1
<b>TEMP.</b>		<b>PRESSURE</b>	<b>I.D.</b>	<b>O.D.</b>
-15° F to 250° F		7200 PSI	3/8"	.77"

- Designed for commercial high pressure cleaning applications.
- An ideal hose for hot water applications.
- Red bend guards on each end.
- Commercial grade.
- Synthetic rubber abrasion resistant wrapped cover.



## 1/2" DOUBLE WIRE 4000 PSI HOSE

ORDER #	FITTINGS	LENGTH	WEIGHT	BOX QTY
B3V00750	1/2" MPT x M swivel	50 ft	19 lb	3
B3V00755	1/2" MPT x M swivel	75 ft	28.5 lb	2
B3V00766	1/2" MPT x M swivel	100 ft	38 lb	2
<b>TEMP.</b>		<b>PRESSURE</b>	<b>I.D.</b>	<b>O.D.</b>
-15° F to 250° F		4000 PSI	1/2"	.81"

**\*\*Jumper Hose lengths available from 2 ft to 12 ft per request\*\***

- Heat resistant synthetic rubber inner tube.
- Designed for high pressure cleaning applications.
- Double wire braided rubber hose.
- Red bend guards on each end.



### REPAIR YOUR OWN HOSE (fittings & ferrules)

Note: each fitting requires a crimp ferrule.

ORDER #	DESCRIPTION	SIZE	WEIGHT	COLOR	BOX QTY
B3R00750	Bulk Hose	350 ft reel	125 lb	Black	1
899400050	Zinc Crimp Ferrule	25.1 mm ± 0.3 mm	—	—	25
898400650	Zinc Fitting	1/2" MPT x Barb	—	—	25
898400651	Zinc Fitting	1/2" MPT x Barb swivel	3.5 oz	—	25
080030845	Rubber Bend Restrictors	for 1/2" Hose	—	Red	25



## 1/2" DOUBLE WIRE 6000 PSI HOSE

ORDER #	FITTINGS	LENGTH	WEIGHT	BOX QTY
B3R00760	1/2" MPT x M swivel	350 ft Reel	143.5 lb	—
B3V00760	1/2" M swivel x M swivel	50 ft	20 lb	2
B3V00765	1/2" M swivel x M swivel	100 ft	37 lb	2
<b>TEMP.</b>		<b>PRESSURE</b>	<b>I.D.</b>	<b>O.D.</b>
-15° F to 250° F		6000 PSI	1/2"	.81"

- Heat resistant synthetic rubber inner tube.
- Designed for high pressure cleaning applications.
- Double wire braided rubber hose.
- Red bend guards on each end.



# HOSES: CARPET



## 1/4" SINGLE WIRE 3000 PSI BLUE CARPET SOLUTION HOSE

ORDER #	FITTINGS	LENGTH	WEIGHT	BOX QTY
B3V00201	1/4" MPT x M swivel	1 ft	0.15 lb	50
B3V00203	1/4" MPT x M swivel	3 ft	0.46 lb	50
B3V00210	1/4" MPT x M swivel	100 ft	11 lb	3
B3V00300	1/4" MPT x M swivel	200 ft	25 lb	1

PRESSURE	TEMP.	I.D.	O.D.
3000 PSI	-15° F to 250° F	1/4"	.44"

- Blue non-marking abrasion resistant smooth synthetic rubber cover.
- Black bend guards on each end.
- Reinforced with one layer of high tensile steel wire.
- Heat resistant synthetic rubber inner tube.
- Designed as a solution hose for carpet cleaning equipment and high pressure cleaning applications.



### REPAIR YOUR OWN HOSE (fittings & ferrules)

**Note: each fitting requires a crimp ferrule.**

ORDER #	DESCRIPTION	SIZE	WEIGHT	COLOR	BOX QTY
B3R00205	Bulk Hose	500 ft reel	72 lb	Blue	1
899300014	Zinc Crimp Ferrule	14.9 mm ± 0.2 mm	—	—	25
898300014	Zinc Fitting	1/4" MPT x Barb	2.6 oz	—	25
898300015	Zinc Fitting	1/4" MPT x Barb Swivel	3.2 oz	—	25
080030814	Rubber Bend Restrictors	for 1/4" hose	—	Black	25



## HOSE BEND PROTECTORS *(extends the life of the hose)*

ORDER #	DESCRIPTION	COLOR
080030814	Fits 1/4" Hose	Black
080030816	Fits 5/16" Hose	Black
080030817	Fits 5/16" Hose	Red
080030838	Fits 3/8" Hose	Black
080030839	Fits 3/8" Hose	Red
080030845	Fits 1/2" Hose	Red
080030870	Fits 3/8" Hose	Red
080030871	Fits 3/8" Hose	Black
080030872	Fits 1/4" Hose	Black
080030875	Fits 3/4" Hose	Black

- Special material that is more UV and ozone resistant than rubber.
- Resistant to cleaning detergents.

### **ALSO AVAILABLE:**

- Assorted colors: #080030871.
  - Special order and minimum quantities.
- Private Label Hose Bend Protectors



#080030814



#080030816



#080030817



#080030838



#080030839



#080030845



#080030870



#080030871



#080030872



#080030875

# HOSES: ACCESSORIES

**FOOD  
GRADE**

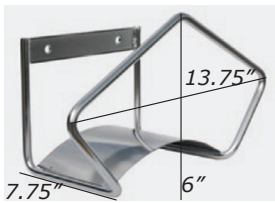

## HOSE HANGER *(stainless steel)*

ORDER #	MATERIAL	DIMENSION	WEIGHT
11006	Polished Stainless Steel	13.75" x 6" x 7.75"	2 lb

- Polished stainless steel.
- Holds 175 ft of 3/8" hose.
- Holds 120 ft of 1/2" hose.
- Holds 90 ft of 3/4" hose.



## SUTTNER SUPERBALLS

ORDER #	DESCRIPTION	COLOR	BOX QTY	BOX WEIGHT
200000505	For 3/8" 4000 PSI hose	Orange	36	1.2 lb
200000515	For 3/8" 6000 PSI hose	Red	36	1.2 lb
200000516	For 1/4" 3000 PSI hose	Blue	36	1.2 lb

- Greatly reduces hose cover wear caused by abrasion.
- Helps keep hose clean and water from damming around it.
- Easy handling and dragging of hose.
- Recommended spacing is 16 inches.
- Easy Installation.



[https://youtu.be/si6\\_qAYcUnE](https://youtu.be/si6_qAYcUnE)



## 1/8" 4800 PSI BLACK SMOOTH HOSE

ORDER #	PRESSURE	TEMP.	I.D.	O.D.	FITTINGS	LENGTH	WEIGHT	BOX QTY
894800025	4800 PSI	160° F	.12"	.27"	1/8" MPT x 1/8" MPT	25 ft	.45 lb	12
894800050	4800 PSI	160° F	.12"	.27"	1/8" MPT x 1/8" MPT	50 ft	.85 lb	6
894800100	4800 PSI	160° F	.12"	.27"	1/8" MPT x 1/8" MPT	100 ft	1.60 lb	3

- Kevlar braid reinforced.
- Seamless nylon inner tube.
- 1" bend radius (2.54 cm).
- Black abrasion resistant polyurethane smooth cover.
- Maximum flow rate up to 1.5 GPM.
- 2.5:1 burst to operating pressure.
- Lightweight and highly flexible.

### REPAIR YOUR OWN HOSE (fittings & ferrules)

**Note: each fitting requires a crimp ferrule.**

ORDER #	DESCRIPTION	SIZE	BOX QTY
899480008	Zinc Crimp Ferrule	6.5 mm - OD	25
898480008	Zinc Fitting	1/8" MPT x 1/8" Barb	25

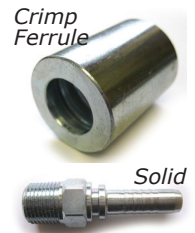

## 3/16" 4800 PSI BLACK SMOOTH HOSE

ORDER #	PRESSURE	TEMP.	I.D.	O.D.	FITTINGS	LENGTH	WEIGHT	BOX QTY
894803050	4800 PSI	160° F	.19"	.39"	1/8" MPT x 1/8" MPT	50 ft	2.05 lb	6
894803100	4800 PSI	160° F	.19"	.39"	1/8" MPT x 1/8" MPT	100 ft	4.50 lb	3

- Polyester braid reinforced
- Seamless nylon inner tube
- Male NPT zinc plated steel fitting
- Black abrasion resistant polyurethane smooth cover
- Maximum flow rate up to 2.5 GPM
- 2.5:1 burst to operating pressure
- Lightweight and highly flexible
- Ideal for 2"-4" diameter lines
- 1.18" bend radius (3.00 cm)

### REPAIR YOUR OWN HOSE (fittings & ferrules)

**Note: each fitting requires a crimp ferrule.**

ORDER #	DESCRIPTION	SIZE	BOX QTY
899480016	Zinc Crimp Ferrule	10.5 mm - OD	25
898480016	Zinc Fitting	1/8" MPT x 3/16" Barb	25

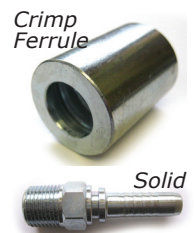

# HOSES: SEWER

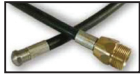

#084400026 sewer hose comes with 4.5 sewer nozzle & M22 nipple

## WIRE BRAID RUBBER SMOOTH SEWER HOSE

ORDER #	PRESSURE	TEMP.	I.D.	O.D.	FITTINGS	BEND RADIUS	LENGTH	WEIGHT
084290050	2900 PSI	140° F	1/8"	.41"	1/8" MPT x 1/4" MPT	1.5"	50 ft	2.35 lb
084290100	2900 PSI	140° F	1/8"	.41"	1/8" MPT x 1/4" MPT	1.5"	100 ft	4.50 lb
084350054	4350 PSI	212° F	1/4"	.44"	1/4" MPT x 1/4" MPT	2.95"	50 ft	4.80 lb
084350104	4350 PSI	212° F	1/4"	.44"	1/4" MPT x 1/4" MPT	2.95"	100 ft	9.45 lb
084350154	4350 PSI	212° F	1/4"	.44"	1/4" MPT x 1/4" MPT	2.95"	150 ft	14.15 lb
084350204	4350 PSI	212° F	1/4"	.44"	1/4" MPT x 1/4" MPT	2.95"	200 ft	18.80 lb
084400025	4400 PSI	160° F	1/4"	.47"	1/8" MPT x 1/8" MPT	1.25"	25 ft	2.35 lb
084400026	4400 PSI	160° F	1/4"	.47"	1/8" x 1/8" 25' w/4.5 nozzle & M22 nipple	1.25"	25 ft	2.4 lb

- Durable wire braid rubber construction, flexible and lightweight for cornering around line elbows.

## 1/4" TEXTILE BRAID THERMOPLASTIC SMOOTH HOSE



ORDER #	FITTINGS	LENGTH	WEIGHT	BOX QTY
894400050	1/4" MPT x 1/4" MPT Swivel	50 ft	4.95 lb	10
894400100	1/4" MPT x 1/4" MPT Swivel	100 ft	9.35 lb	6
894400150	1/4" MPT x 1/4" MPT Swivel	150 ft	14.41 lb	4
894400200	1/4" MPT x 1/4" MPT Swivel	200 ft	19.31 lb	3
894400300	1/4" MPT x 1/4" MPT Swivel	300 ft	26.5 lb	2

PRESSURE	TEMP.	I.D.	O.D.
4400 PSI	160° F	.25"	.47"

- Polyester braid reinforced.
- Seamless thermoplastic inner tube.
- Male NPT zinc plated steel fitting.
- Black abrasion resistant thermoplastic smooth cover.
- Maximum flow rate up to 4.0 GPM.
- 2.5:1 burst to operating pressure.
- Lightweight and highly flexible.
- Ideal for 2"-4" diameter lines.
- 1.57 bend radius (3.99 cm).



### REPAIR YOUR OWN HOSE (fittings & ferrules)

Note: each fitting requires a crimp ferrule.

ORDER #	DESCRIPTION	SIZE	BOX QTY
899440014	Zinc Crimp Ferrule	13.5 mm - OD	25
898440014	Zinc Fitting	1/4" MPT x Barb	25
898440015	Zinc Fitting	1/4" MPT x Barb swivel	25

## 3/8" 4000 PSI BLACK SMOOTH HOSE

ORDER #	FITTINGS	LENGTH	WEIGHT	BOX QTY	
894000050	3/8" MPT x 3/8" MPT Swivel	50 ft	13.35 lb	6	
894000100	3/8" MPT x 3/8" MPT Swivel	100 ft	27.15 lb	3	
894000150	3/8" MPT x 3/8" MPT Swivel	150 ft	40.85 lb	2	
894000200	3/8" MPT x 3/8" MPT Swivel	200 ft	54.15 lb	1	
894000250	3/8" MPT x 3/8" MPT Swivel	250 ft	65.5 lb	1	
894000300	3/8" MPT x 3/8" MPT Swivel	300 ft	79.2 lb	1	
		<b>PRESSURE</b>	<b>TEMP.</b>	<b>I.D.</b>	<b>O.D.</b>
		4000 PSI	160° F	.38"	.63"

- Reinforced with (1) layer of steel wire braid.
- Seamless nylon inner tube.
- Highly flexible.
- Black abrasion resistant polyurethane smooth cover.
- Maximum flow rate up to 9.0 GPM.
- 2.51 burst to operating pressure.
- Ideal for 4"-8" diameter lines.
- 3.94" bend radius (10.1 cm).

### REPAIR YOUR OWN HOSE (fittings & ferrules)

Note: each fitting requires a crimp ferrule.

ORDER #	DESCRIPTION	SIZE	BOX QTY
899400045	Zinc Crimp Ferrule	19 mm - OD	25
898400038	Zinc Fitting	3/8" MPT x Barb	25
898400039	Zinc Fitting	3/8" MPT x Barb swivel	25



## 1/2" 4000 PSI GREEN SMOOTH HOSE

ORDER #	FITTINGS	LENGTH	WEIGHT		
894012050	1/2" MPT x 1/2" MPT Swivel	50 ft	19.5 lb		
894012100	1/2" MPT x 1/2" MPT Swivel	100 ft	45.9 lb		
894012200	1/2" MPT x 1/2" MPT Swivel	200 ft	75 lb		
894012300	1/2" MPT x 1/2" MPT Swivel	300 ft	126.6 lb		
894012500	1/2" MPT x 1/2" MPT Swivel	500 ft	211 lb		
		<b>PRESSURE</b>	<b>TEMP.</b>	<b>I.D.</b>	<b>O.D.</b>
		4000 PSI	160° F	.50"	.81"

- Reinforced with (2) layers of steel wire braid.
- Seamless nylon inner tube.
- Green abrasion resistant polyurethane smooth cover.
- Maximum flow rate up to 15 GPM.
- Ideal for 6"-12" diameter lines.
- 3.94" bend radius (10.1 cm).

### REPAIR YOUR OWN HOSE (fittings & ferrules)

Note: each fitting requires a crimp ferrule.

ORDER #	DESCRIPTION	SIZE	BOX QTY
899400012	Zinc Crimp Ferrule	23 mm - OD	15
898400050	Zinc Fitting	1/2" MPT x Barb	15
898400051	Zinc Fitting	1/2" MPT x Barb swivel	15



# SEWER ACCESSORIES

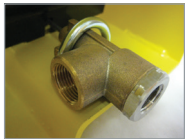

Valve housing

## **FOOT ACTUATED VALVE (3000 psi)**

Foot controlled valves allow both hands to be free to control the sewer hose pulling hose back and forth to flush pipes.

ORDER #	PRESSURE	TEMP.	INLET	OUTLET	FLOW RATE	WEIGHT
999000012	3000 PSI	320° F	3/8" FPT	1/4" FPT	8 GPM	7 lb

Complete Valve Repair Kit: #200851484

- Inlet and outlet are positioned to help keep hose out of the way.
- Heavy gauge steel construction for durability and stability.
- Pedal and valve are in protective housing.



NEW!



#999002320

## **FOOT ACTUATED VALVES**

Foot controlled valves allow both hands to be free to control the sewer hose pulling hose back and forth to flush pipes.

ORDER #	PRESSURE	TEMP.	INLET	OUTLET	FLOW RATE	WEIGHT
999002305	5000 PSI	300° F	3/8" FPT	1/4" FPT	12 GPM	15 lb
999002700	5000 PSI	300° F	3/8" FPT	1/4" FPT	12 GPM	15 lb
999002320	4000 PSI	300° F	1/2" FPT Swivel	1/2" FPT	21 GPM	15 lb

Repair Kits: #202300490  
#202700490

- Heavy gauge steel construction for durability and stability.
- Uses the ST-2305 or ST-2700 spray guns as a control valve.
- ST-2320 foot actuated valve has stainless steel components.
- Pedal and valve are in protective housing.
- Inlet and outlet are positioned to help keep hose out of the way.

## **ST-550 FOOT ACTUATED VALVE (7300 psi)**

Foot controlled valves allow both hands to be free to control the sewer hose pulling hose back and forth to flush pipes.

ORDER #	PRESSURE	TEMP.	INLET	OUTLET	FLOW RATE	WEIGHT
200550500	7300 PSI	300° F	1/4" FPT	1/4" FPT	10.5 GPM	9 lb

Repair Kit: #203600490

- Inlet and outlet are positioned to help keep hose out of the way.
- Stainless steel construction.
- Pedal and valve are in protective housing.

# FOAMING

FOAM CHART: 92

FOAM INJECTORS: 94

DOSING NOZZLES: 108

FOAMERS: 109

FOAM NOZZLES: 110

FOAM LANCES: 112

FOAM BRUSH: 113

FOAM JET: 114

FOAMING ACCESSORIES: 115



















# FOAMING: FOAM CHART

## DETERMINE THE FOAM COMPONENTS YOU NEED

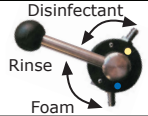
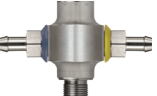





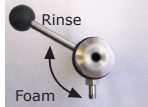





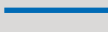

- 1** SELECT A FOAM INJECTOR TO FIT YOUR MACHINE & JOB  
Use the chart below for selection of Components
- 2** SELECT THE SPRAY GUN TO FIT YOUR REQUIREMENTS & MACHINE  
Spray Gun Chart below – NOTE GPM ratings for gun selection
- 3** SELECT THE FOAMER THAT BEST SUITS YOUR CRITERIA

**1**

### INJECTORS

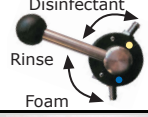
		Food Grade	# of Chemicals	Flow Rate	Bypass Rinse Option	Description / Diagram
	<b>ST-160</b>			1-18 GPM		page 94
	<b>ST-160.3</b>			1-24 GPM		page 98
	<b>ST-164</b>			1-18 GPM		page 100
	<b>ST-166</b>			1-18 GPM		page 102
	<b>ST-167</b>			1-18 GPM		page 104



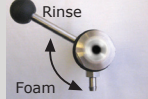



### COMPRESSED AIR INJECTORS

		Food Grade	# of Chemicals	Flow Rate	Bypass Option	Description / Diagram
	<b>ST-160.2</b>			1-18 GPM		page 97
	<b>ST-160.3A</b>			1-24 GPM		page 99
	<b>ST-164A</b>			1-18 GPM		page 101
	<b>ST-168</b>			1-18 GPM		page 106

# FOAMING: FOAM CHART

**2**

## SPRAY GUNS

		Food Grade	Below 6 GPM	Above 6 GPM	Relax Action Trigger	Description / Diagram
	<b>ST-2605F</b>	—	✓	—	✓	page 17
	<b>ST-2620F</b>	—	✓	✓	✓	page 18
	<b>ST-2720F</b>		✓	✓	✓	page 20
	<b>ST-3225</b>		—	✓	—	page 22

## COMPRESSED AIR SPRAY GUNS

		Food Grade	Below 6 GPM	Above 6 GPM	Relax Action Trigger	Description / Diagram
	<b>ST-2620F w/ Foam Lance</b>	—	—	—	✓	page 18

**3**

## FOAMERS

		Food Grade	Below 6 GPM	Above 6 GPM	Description / Diagram
	<b>ST-73</b>	—	✓	—	page 109
	<b>ST-73H</b>	—	—	✓	page 109
	<b>SA-73</b>	—	✓	—	page 109
	<b>ST-75</b>	—	✓	—	page 110
	<b>ST-75S</b>		✓	—	page 110
	<b>ST-75.2</b>	—	✓	✓	page 111
	<b>ST-76</b>	—	—	✓	page 111
	<b>ST-72</b>	—	✓	—	page 114
	<b>ST-72F</b>		✓	—	page 114
	<b>ST-175</b>	—	✓	—	page 112
	<b>ST-176</b>	—	—	✓	page 113

# FOAMING: FOAM INJECTORS

**FOOD  
GRADE**

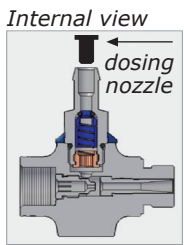
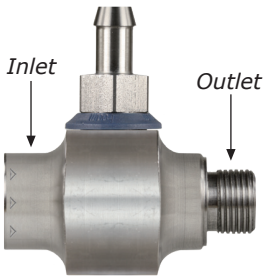

## ST-160 CHEMICAL INJECTOR (single chemical)

ORDER #	NOZZLE / ORIFICE
200160499	3.0
200160500	3.5
200160505	4.0
200160510	4.5
200160515	5.5
200160520	6.0
200160525	7.0
200160530	8.0
200160535	8.5
200160540	9.0
200160545	10.0
200160550	11.0
200160555	12.0
200160560	12.5
200160565	14.0
200160570	15.0
200160575	18.0

- Durable Stainless Steel housing.
- 10 metering/dosing nozzles included (see page 108 for dilution ratios).
- Temperature: 194° F.
- Inlet: 3/8" F.
- Outlet: 3/8" M.
- Pressure: 1000-5000 PSI.
- Flow Rate: 1-18 GPM.
- Weight .71 lb.
- **Optimum foam created 130°F or less**

### ALSO AVAILABLE:

Extreme chemical injectors for PH Level 2.0 or below. Available in all orifice sizes.

### MOUNTING BRACKET:



#200160160  
\*Sold Separately



## ST-160 System Diagram

Flow Rate: 1 GPM - 18 GPM  
Min. PSI: 1000  
Max. PSI: 5000

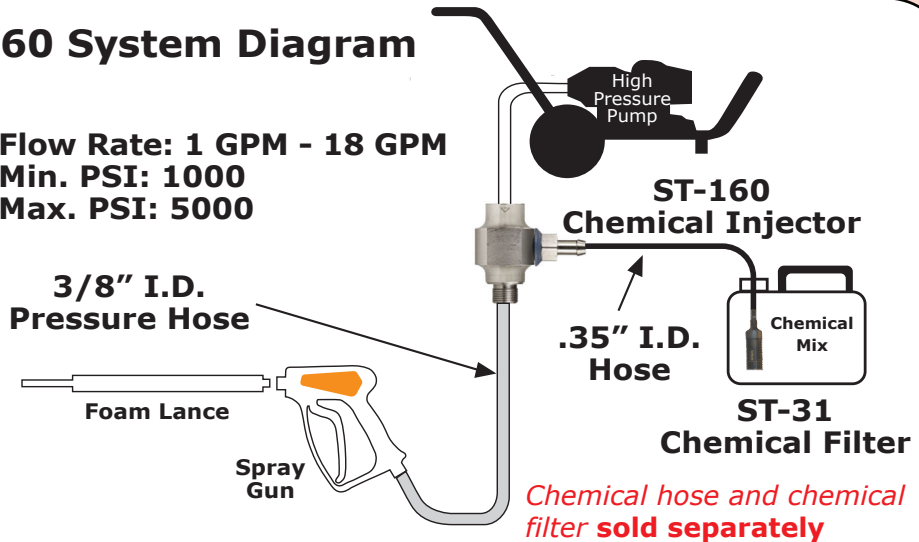

### Under 6 GPM Components



### Over 6 GPM Components



# FOAMING: FOAM INJECTORS

## ST-160M CHEMICAL INJECTOR (single chemical)

With ST-161 Metering/Dosing Valve.

ORDER #	NOZZLE / ORIFICE
200160600	3.0
200160601	3.5
200160602	4.0
200160603	4.5
200160604	5.5
200160605	6.0
200160606	7.0
200160607	8.0
200160608	8.5
200160609	9.0
200160610	10.0
200160611	11.0
200160612	12.0
200160613	12.5
200160614	14.0
200160615	15.0
200160616	18.0

- Conserves chemicals.
- Locks in position for accurate metering.
- Multiple metering positions.
- Temperature: 194° F.
- Inlet: 3/8" F.
- Outlet: 3/8" M.
- Pressure: 1000-5000 PSI.
- Flow Rate: 1-18 GPM.
- Weight 1.25 lb.
- **Optimum foam created 130°F or less.**

### ALSO AVAILABLE:

Extreme chemical injectors for PH Level 2.0 or below.  
Available in all orifice sizes.

**FOOD  
GRADE**

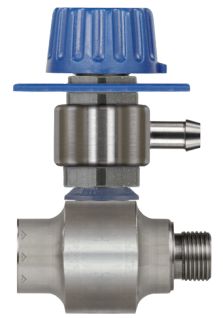

Easy to read dial



## ST-160M System Diagram

Flow Rate: 1 GPM - 18 GPM  
Min. PSI: 1000  
Max. PSI: 5000

3/8" I.D.  
Pressure Hose

Foam Lance  
Spray Gun  
*Chemical hose and  
chemical filter  
sold separately*

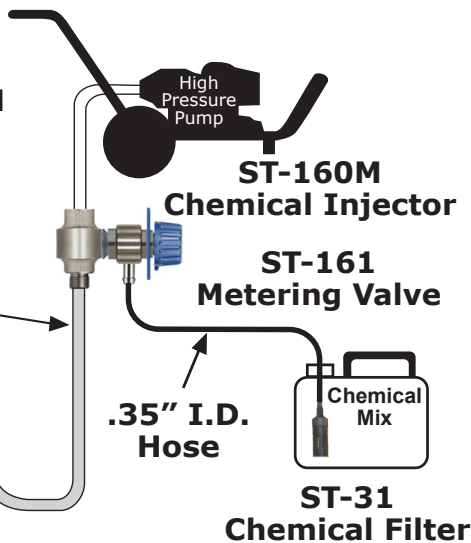

## MOUNTING BRACKET:



#200160160  
**\*Sold  
Separately**

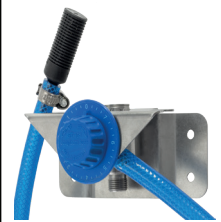

### Under 6 GPM Components



### Over 6 GPM Components



# FOAMING: FOAM INJECTORS



## UNIVERSAL FOAM INJECTOR KIT

**Includes ST-75 Foam nozzle & ST-160 injector.**

Adapts to any pressure washer.

ORDER #	KIT	ORIFICE
999160751	1	2.0 - 3.5
999160752	2	4.0 - 5.5
999160753	3	6.5 - 7.0

- Fits all orifice sizes.
- **Optimum foam created 130°F or less.**

## ST-75 FOAM NOZZLE

ST-75 produces thick foam for an easy and safe application and to save on chemical usage by reducing splash and drift of chemicals.

PRESSURE	INLET	WEIGHT
5000 PSI	1/4" F	.31 lb

## ST-160 STAINLESS STEEL INJECTOR

Durable stainless steel housing and single chemical.

PRESSURE	INLET	OUTLET	WEIGHT
5000 PSI	3/8" F	3/8" M	.71 lb

## ALSO AVAILABLE: with ST-76 Foam Nozzle

For high volume applications over 6 GPM.

ORDER #	KIT	ORIFICE
999160764	4	7.5 - 8.5
999160765	5	9.0 - 12.0



See in action!

<https://www.youtube.com/watch?v=YUysnpByoWg>

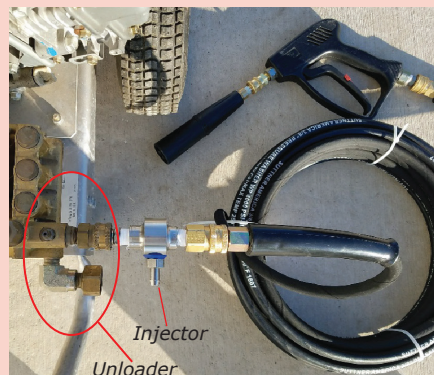

Foam injector conveniently attaches after the pump/unloader on your pressure washer.

# FOAMING: FOAM INJECTORS

## ST-160.2 CHEMICAL INJECTOR (single chemical)

With ST-161 Metering/Dosing Valve.

ORDER #	NOZZLE / ORIFICE
200160630	3.0
200160631	3.5
200160632	4.0
200160633	4.5
200160634	5.5
200160635	6.0
200160636	7.0
200160637	8.0
200160638	8.5
200160639	9.0
200160640	10.0
200160641	11.0
200160642	12.0
200160643	12.5
200160644	14.0
200160645	15.0
200160646	18.0

- Conserves chemicals.
- Locks in position for accurate metering.
- Multiple metering positions.
- Temperature: 194° F.
- Inlet: 1/2" F.
- Outlet: 1/2" F.
- Pressure: 90-5000 PSI.
- Flow Rate: 1-18 GPM.
- Weight: 2.20 lb.
- Optimum foam created 130°F or less.

### ALSO AVAILABLE:

Extreme chemical injectors for PH Level 2.0 or below.

Available in all orifice sizes.



The use of compressed air provides energy to propel foam faster and farther during application.

**FOOD GRADE**

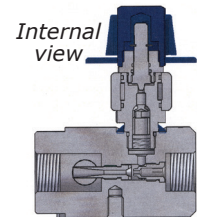

## ST-160.2 System Diagram

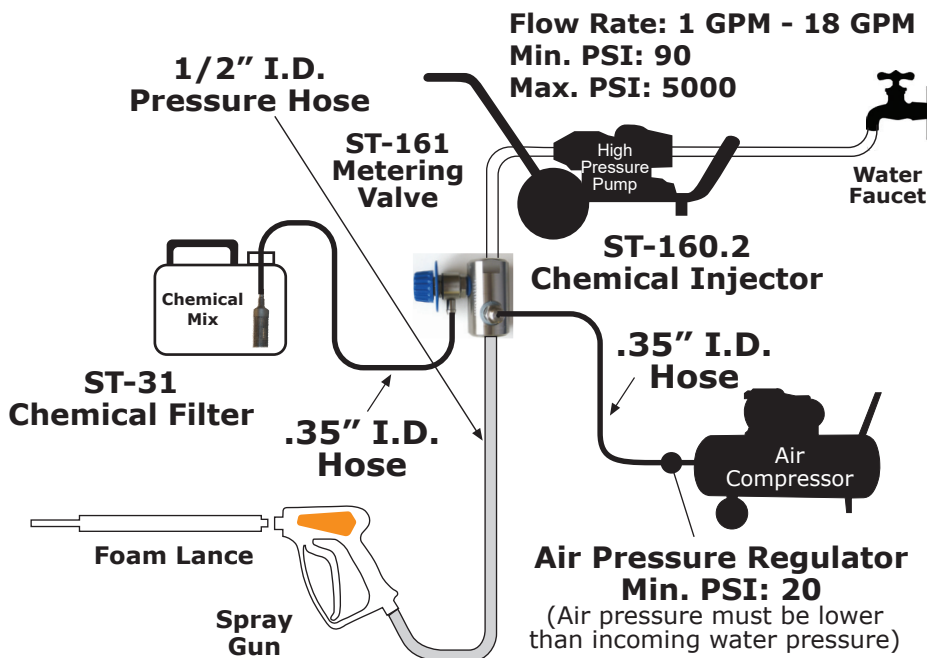

Chemical hose and chemical filter sold separately

Under 6 GPM Components



ST-2620F Spray Gun System

## MOUNTING BRACKET:

Included with Injector



#200168420



Also available:

Two component inlet  
#200164355  
see page 116

# FOAMING: FOAM INJECTORS

**FOOD  
GRADE**



## ST-160.3 CHEMICAL INJECTOR (high flow)

ORDER #	NOZZLE/ ORIFICE
200160330	4.5
200160326	6.0
200160331	7.5
200160332	9.0
200160347	45.0
200160348	54.0

**\*AVAILABLE IN  
ADDITIONAL  
ORIFICE SIZES**

- For large water quantities and high dosing.
- Three pairs of injector and nozzle in one housing and can be configured independently.
- Includes (3) dosing nozzles sets.
- Multiple metering positions.
- Temperature: 194° F.
- Inlet: 1/2" F.
- Outlet: 1/2" F.
- Pressure: 90 - 5000 PSI.
- Flow Rate: 1 GPM - 24 GPM.
- Weight: 3.55 lb.
- **Optimum foam created 130°F or less.**

### ALSO AVAILABLE:

Extreme chemical injectors for PH Level 2.0 or below.  
Available in all orifice sizes.

### MOUNTING BRACKET:

Included with  
Injector

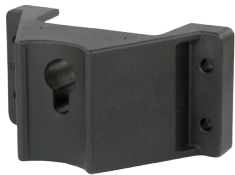

#200168420

## ST-160.3 System Diagram

Flow Rate: 1 GPM - 24 GPM  
Min. PSI: 90  
Max. PSI: 5000

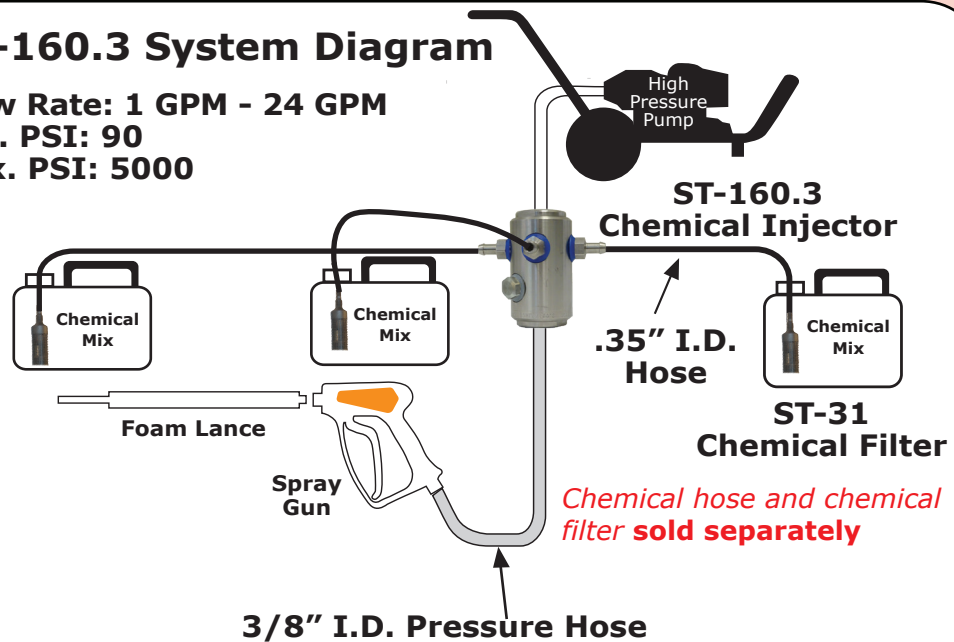

### Under 6 GPM Components



### Over 6 GPM Components



### Also available:

Two component inlet  
#200164355  
see page 116

# FOAMING: FOAM INJECTORS

## ST-160.3A CHEMICAL INJECTOR (high dosages)

ORDER #	NOZZLE/ ORIFICE
200160300	4.5
200160302	9.0
200160318	54.0

**\*AVAILABLE IN  
ADDITIONAL  
ORIFICE SIZES**

- For large water quantities and high dosing.
- Three pairs of injector and nozzle in one housing.
- and can be configured independently.
- Includes (3) dosing nozzle sets.
- Multiple metering positions.
- Temperature: 194° F.
- Inlet: 1/2" F.
- Outlet: 1/2" F.
- Pressure: 90 - 5000 PSI.
- Flow Rate: 1 GPM - 24 GPM.
- Weight: 3.55 lb.
- **Optimum foam created 130°F or less.**

### ALSO AVAILABLE:

Extreme chemical injectors for PH Level 2.0 or below.  
Available in all orifice sizes.

**FOOD  
GRADE**

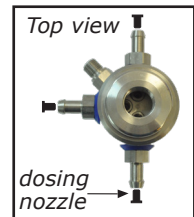

## ST-160.3A System Diagram

Flow Rate: 1 GPM - 24 GPM  
Min. PSI: 90  
Max. PSI: 5000

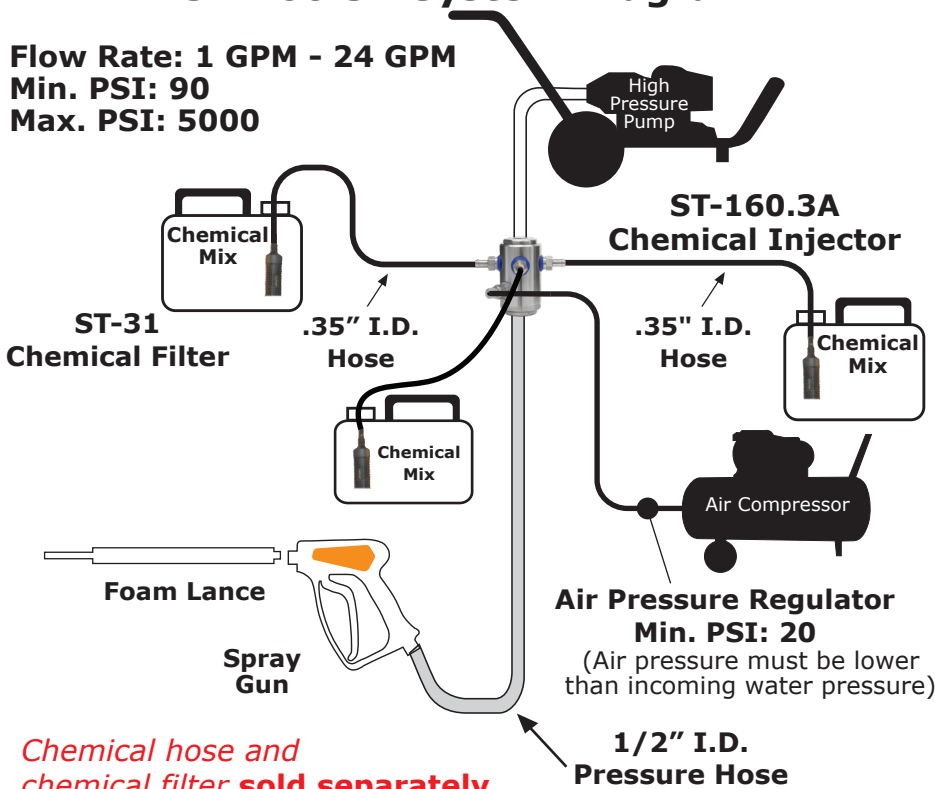

Under 6 GPM Components



## MOUNTING BRACKET:

Included with  
Injector

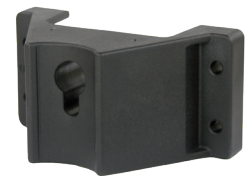

#200168420



The use of compressed air provides energy to propel foam faster and farther during application.



Also available:

Two component inlet  
#200164355  
see page 116

# FOAMING: FOAM INJECTORS

**FOOD  
GRADE**

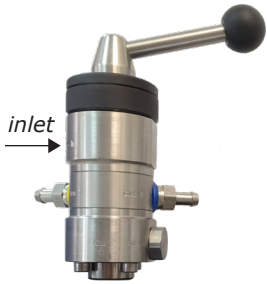

**MOUNTING  
BRACKET:**  
Included with  
Injector

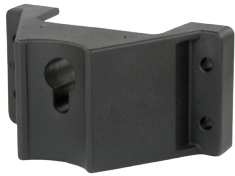

#200168420



**Also available:**  
Two component inlet  
#200164355  
see page 116

## ST-164 CHEMICAL BYPASS INJECTOR

ORDER #	NOZZLE/ ORIFICE
200164499	3.0
200164500	3.5
200164502	4.0
200164503	4.5
200164504	5.5
200164505	6.0
200164506	7.0
200164507	8.0
200164508	8.5
200164509	9.0
200164510	10.0
200164511	11.0
200164512	12.0
200164513	12.5
200164514	14.0
200164516	18.0

- Durable stainless steel construction.
- Food grade quality and specifications.
- 20 dosing nozzles included.
- Integrated lever that allows you to go from disinfectant to foam to rinse.
- Temperature: 212° F.
- Inlet: 3/8" F.
- Outlet: 1/2" F.
- Pressure: 1000-5000 PSI.
- Flow Rate: 1-18 GPM.
- Weight: 4.80 lb.
- **Optimum foam created 130°F or less**

### ALSO AVAILABLE:

Extreme chemical injectors for PH Level 2.0 or below.  
Available in all orifice sizes.

## ST-164 System Diagram

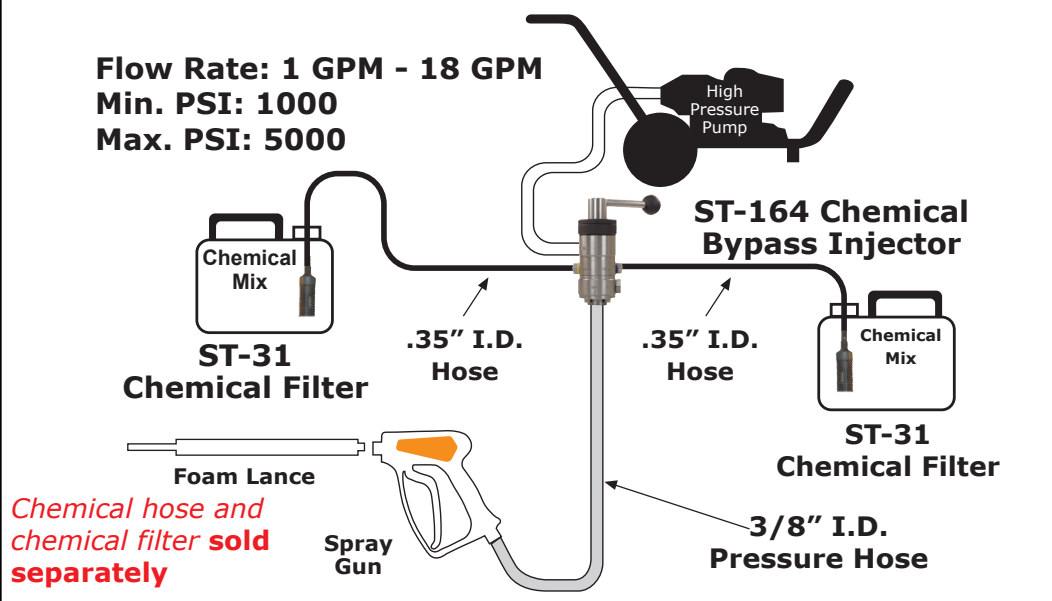

### Under 6 GPM Components



### Over 6 GPM Components



# FOAMING: FOAM INJECTORS

## ST-164A CHEMICAL BYPASS INJECTOR (with air intake)

With integrated lever that allows you to go from disinfectant to foam to rinse.

ORDER #	NOZZLE/ ORIFICE
200164599	3.0
200164600	3.5
200164602	4.0
200164603	4.5
200164604	5.5
200164605	6.0
200164606	7.0
200164607	8.0
200164608	8.5
200164609	9.0
200164610	10.0
200164611	11.0
200164612	12.0
200164613	12.5
200164614	14.0
200164616	18.0

- Durable stainless steel construction.
- Food grade quality and specifications.
- 20 dosing nozzles included.
- Integrated lever that allows you to go from disinfectant to foam to rinse.
- Temperature: 212° F.
- Inlet: 3/8" F.
- Outlet: 1/2" F.
- Pressure: 90-5000 PSI.
- Flow Rate: 1-18 GPM.
- Weight: 2.20 lb.

• **Optimum foam created 130°F or less.**

### ALSO AVAILABLE:

Extreme chemical injectors for PH Level 2.0 or below. Available in all orifice sizes.

**FOOD  
GRADE**

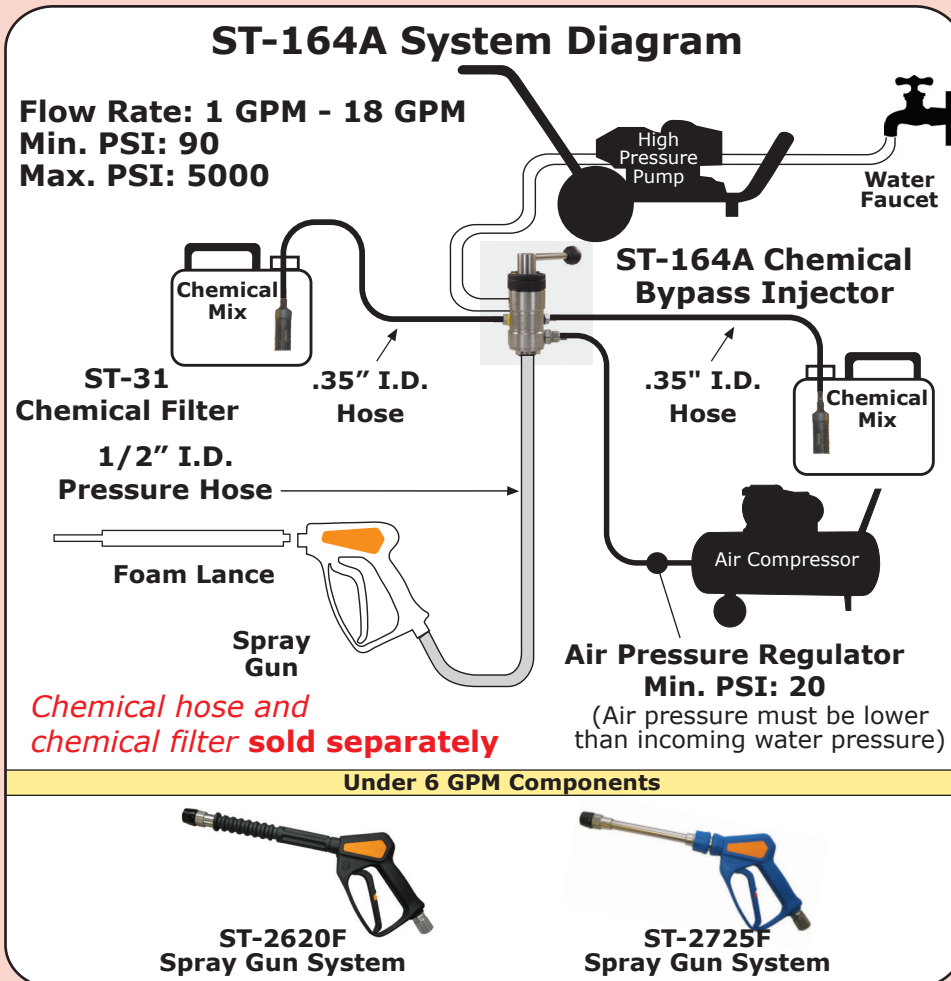

### MOUNTING BRACKET:

Included with Injector



#200168420



The use of compressed air provides energy to propel foam faster and farther during application.



Also available:  
Two component inlet  
#200164355  
see page 116

# FOAMING: FOAM INJECTORS

**FOOD  
GRADE**

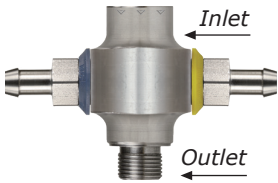

## ST-166 DUAL CHEMICAL INJECTOR (stainless steel)

Use for chemical & foam applications.

ORDER #	NOZZLE / ORIFICE
200166499	3.0
200166500	3.5
200166505	4.0
200166510	4.5
200166515	5.5
200166520	6.0
200166525	7.0
200166530	8.0
200166535	8.5
200166540	9.0
200166545	10.0
200166550	11.0
200166555	12.0
200166560	12.5
200166565	14.0
200166570	15.0
200166580	18.0

- Designed to inject and mix 2 chemicals simultaneously.
- Durable stainless steel.
- 20 dosing nozzles to control chemical suction included (see page 108 for dilution ratios).
- Temperature: 194° F.
- Inlet: 3/8" F.
- Outlet: 3/8" M.
- Pressure: 1000-5000 PSI.
- Flow Rate: 1-18 GPM.
- Weight: .75 lb.

• **Optimum foam created 130°F or less.**

### ALSO AVAILABLE:

Extreme chemical injectors for PH Level 2.0 or below. Available in all orifice sizes.

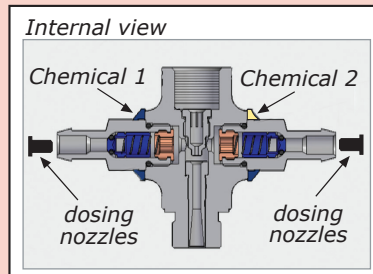

## ST-166 System Diagram

Flow Rate: 1 GPM - 18 GPM  
Min. PSI: 1000  
Max. PSI: 5000

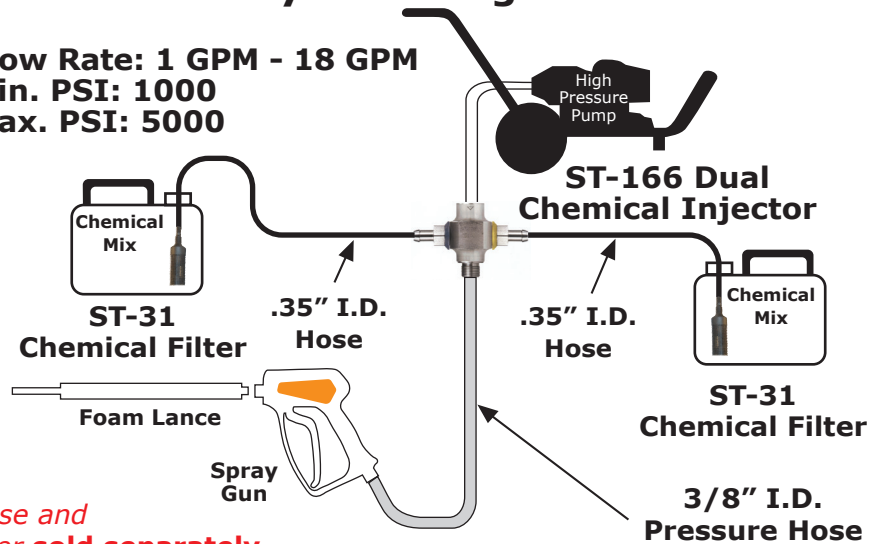

Chemical hose and chemical filter **sold separately**

### Under 6 GPM Components



### Over 6 GPM Components



# FOAMING: FOAM INJECTORS

## ST-166M DUAL CHEMICAL INJECTOR (stainless steel)

With ST-161 metering valves.

ORDER #	NOZZLE / ORIFICE
200166600	3.5
200166605	4.0
200166620	6.0
200166625	7.0
200166640	9.0
200166670	15.0

- Designed to inject and mix 2 chemicals simultaneously.
- Durable stainless steel.
- Multiple metering positions.
- Temperature: 194° F.
- Inlet: 3/8" F.
- Outlet: 3/8" M.
- Pressure: 1000-5000 PSI.
- Flow Rate: 1-18 GPM.
- Weight: 1.35 lb.
- **Optimum foam created 130°F or less.**

### ALSO AVAILABLE:

Extreme chemical injectors for PH Level 2.0 or below. Available in all orifice sizes.

**FOOD  
GRADE**



## ST-166M System Diagram

Flow Rate: 1 GPM - 18 GPM  
Min. PSI: 1000  
Max. PSI: 5000

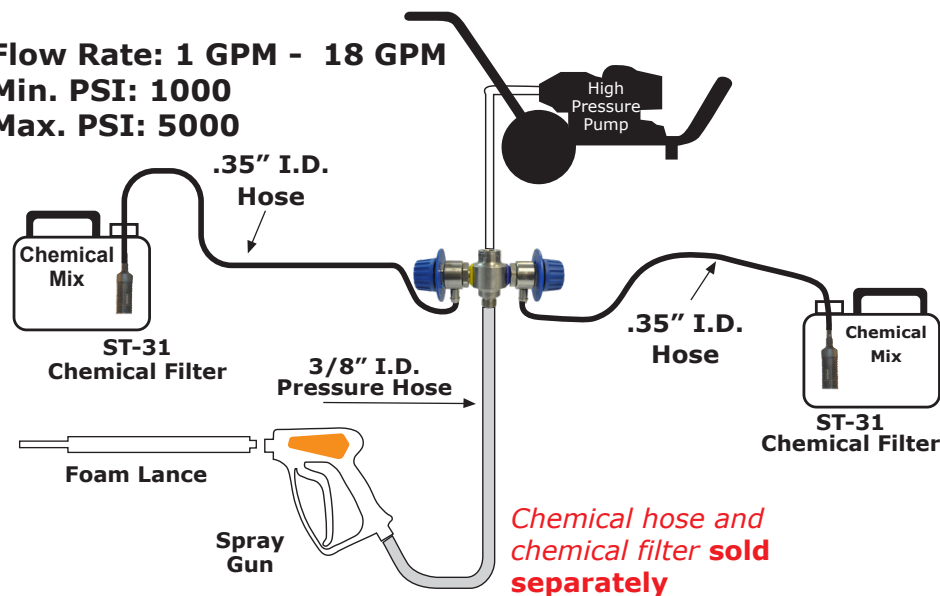

### Under 6 GPM Components



### Over 6 GPM Components



# FOAMING: FOAM INJECTORS

**FOOD  
GRADE**

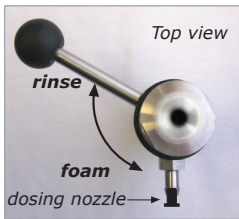

## ST-167 CHEMICAL BYPASS INJECTOR (stainless steel)

With integrated lever that allows you to go from chemical to rinse.

ORDER #	NOZZLE / ORIFICE
200167500	3.0
200167501	3.5
200167502	4.0
200167503	4.5
200167504	5.5
200167505	6.0
200167506	7.0
200167507	8.0
200167508	8.5
200167509	9.0
200167510	10.0
200167511	11.0
200167512	12.0
200167513	12.5
200167514	14.0
200167515	15.0
200167516	18.0

- Food grade quality and specifications.
- Integrated lever that allows you to go from chemical to rinse.
- Durable stainless steel construction.
- 10 dosing nozzles included. (See page 108 for dilution ratios)
- Temperature: 212° F.
- Inlet: 3/8" F.
- Outlet: 3/8" F.
- Pressure: 1000-5000 PSI.
- Flow Rate: 1 - 18 GPM.
- Weight: 2.38 lb.
- **Optimum foam created 130°F or less.**

### ALSO AVAILABLE:

Extreme chemical injectors for PH Level 2.0 or below. Available in all orifice sizes.

## MOUNTING BRACKET:

Included with Injector



#200168420

## ST-167 System Diagram

Flow Rate: 1 GPM - 18 GPM  
Min. PSI: 1000  
Max. PSI: 5000

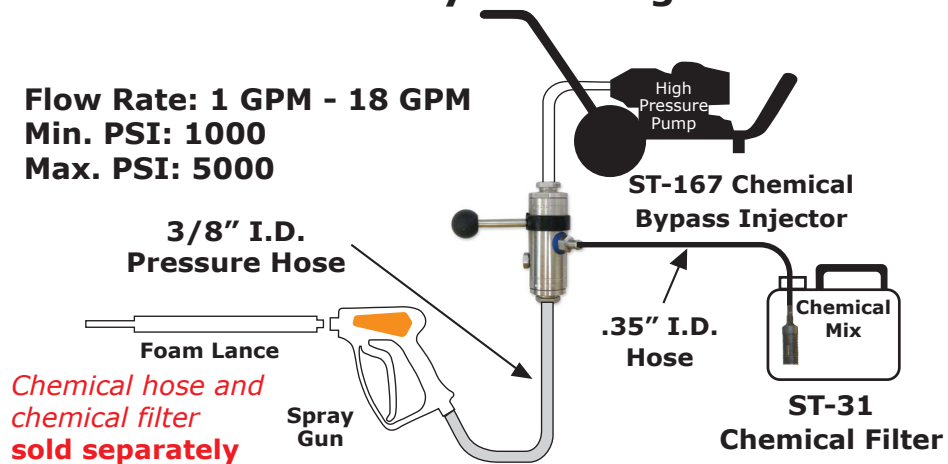

### Under 6 GPM Components



### Over 6 GPM Components



Also available:  
Two component inlet  
#200164355  
see page 116

# FOAMING: FOAM INJECTORS

## ST-167M CHEMICAL BYPASS INJECTOR (stainless steel)

With ST-161 metering/dosing valve.

ORDER #	NOZZLE / ORIFICE
200167600	3.0
200167601	3.5
200167602	4.0
200167603	4.5
200167604	5.5
200167605	6.0
200167606	7.0
200167607	8.0
200167608	8.5
200167609	9.0
200167610	10.0
200167611	11.0
200167612	12.0
200167613	12.5
200167614	14.0
200167615	15.0
200167616	18.0

- Food grade quality and specifications.
- Integrated lever that allows you to go from chemical to rinse.
- Multiple metering positions.
- Temperature: 212° F.
- Inlet: 3/8" F.
- Outlet: 3/8" F.
- Pressure: 1000-5000 PSI.
- Flow Rate: 1-18 GPM.
- Weight: 2.7 lb.
- **Optimum foam created 130°F or less.**

**FOOD  
GRADE**

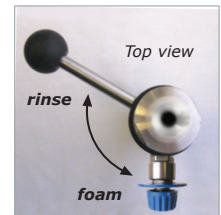

### ST-167M System Diagram

**Flow Rate: 1 GPM - 18 GPM**  
**Min. PSI: 1000**  
**Max. PSI: 5000**

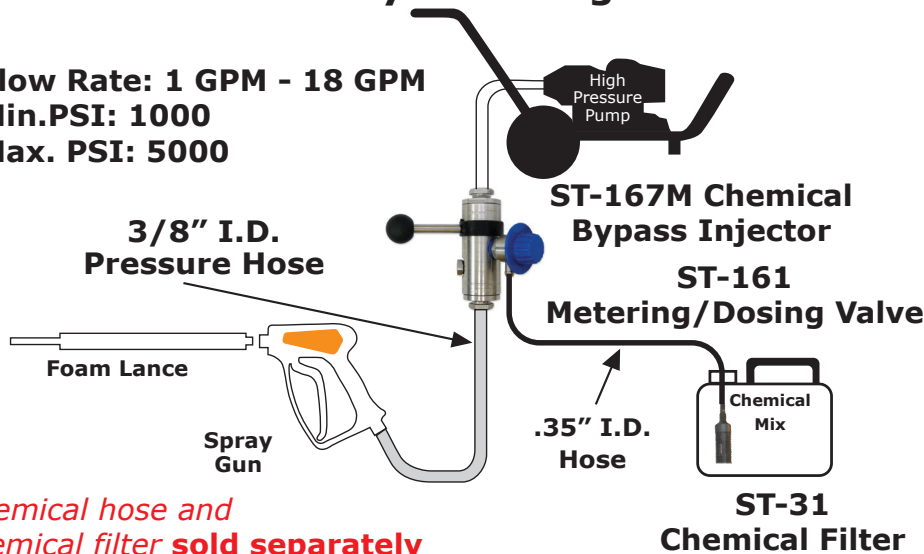

*Chemical hose and chemical filter sold separately*

### MOUNTING BRACKET:

*Included with Injector*

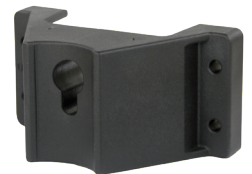

#200168420

#### Under 6 GPM Components



#### Over 6 GPM Components



**Also available:**  
 Two component inlet  
 #200164355  
 see page 116

# FOAMING: FOAM INJECTORS

**FOOD  
GRADE**

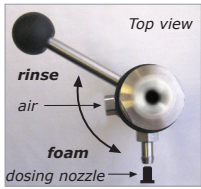

## ST-168 CHEMICAL BYPASS INJECTOR (stainless steel)

ORDER #	NOZZLE / ORIFICE
200168500	3.0
200168505	3.5
200168515	4.0
200168525	4.5
200168535	5.5
200168545	6.0
200168555	7.0
200168556	8.0
200168558	8.5
200168559	9.0
200168560	10.0
200168561	11.0
200168562	12.0
200168665	12.5
200168564	14.0
200168565	15.0
200168568	18.0

- Food grade quality and specifications.
- Integrated lever that allows you to go from chemical to rinse.
- Durable stainless steel construction.
- 10 dosing nozzles included. (See page 108 for dilution ratios)
- Temperature: 212° F.
- Inlet: 3/8" F.
- Outlet: 1/2" F.
- Pressure: 90-5000 PSI.
- Flow Rate: 1-18 GPM.
- Weight: 2.38 lb.

• **Optimum foam created 130°F or less.**

### ALSO AVAILABLE:

Extreme chemical injectors for PH Level 2.0 or below. Available in all orifice sizes.

## MOUNTING BRACKET:

Included with Injector



#200168420



**Compressed Air Only**

The use of compressed air provides energy to propel foam faster and farther during application.



Also available:

Two component inlet  
#200164355  
see page 116

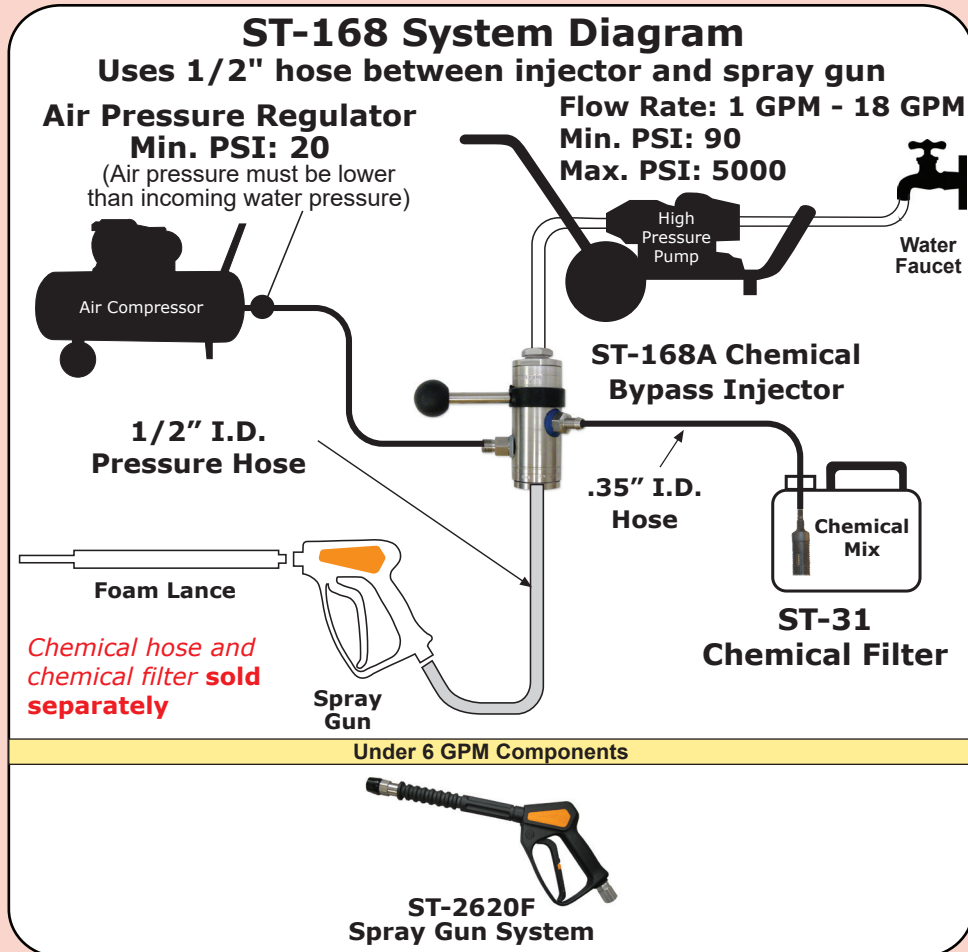

# FOAMING: FOAM INJECTORS

## ST-168M CHEMICAL BYPASS INJECTOR (stainless steel)

With ST-161 metering/dosing valve & air module.

ORDER #	NOZZLE / ORIFICE
200168600	3.0
200168601	3.5
200168602	4.0
200168603	4.5
200168604	5.5
200168605	6.0
200168606	7.0
200168607	8.0
200168608	8.5
200168609	9.0
200168610	10.0
200168612	11.0
200168614	12.0
200168616	12.5
200168617	14.0
200168618	15.0
200168619	18.0

- Food grade quality and specifications.
- Integrated lever that allows you to go from chemical to rinse.
- Multiple metering positions.
- Uses compressed air.
- Temperature: 212° F.
- Inlet: 3/8" F.
- Outlet: 1/2" F.
- Pressure: 90-5000 PSI.
- Flow Rate: 1-18 GPM.
- Weight: 2.7 lb.

• **Optimum foam created 130°F or less.**

### ALSO AVAILABLE:

Extreme chemical injectors for PH Level 2.0 or below.  
Available in all orifice sizes.

**FOOD  
GRADE**

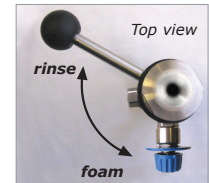

## ST-168M System Diagram

Uses 1/2" hose between injector and spray gun

Flow Rate: 1 GPM - 18 GPM  
Min. PSI: 90  
Max. PSI: 5000

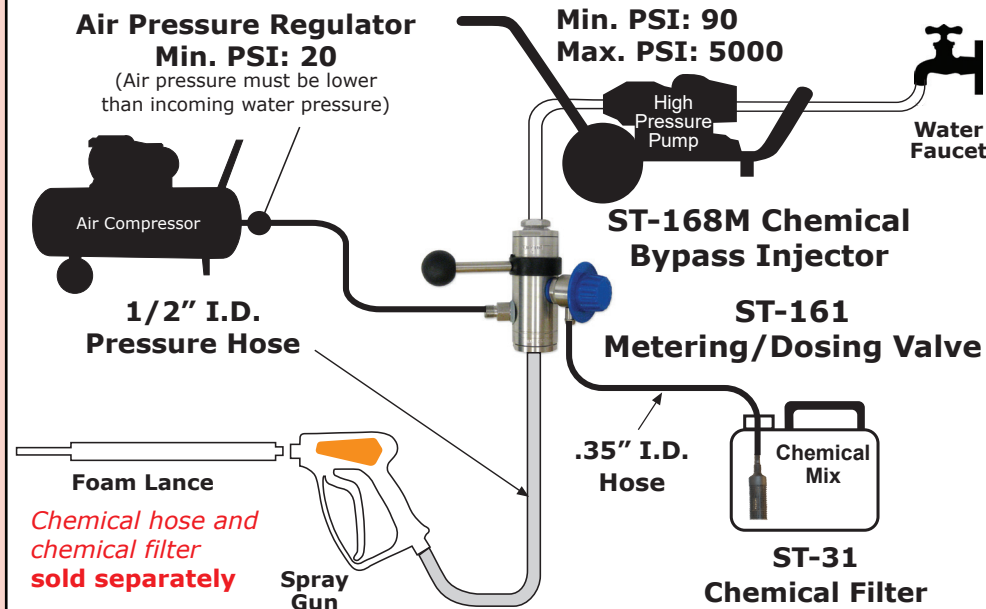

Under 6 GPM Components



## MOUNTING BRACKET:

Included with Injector



#200168420



**Compressed Air Only**

The use of compressed air provides energy to propel foam faster and farther during application.



**Also available:**  
Two component inlet  
#200164355  
see page 116

# FOAMING: DOSING NOZZLES



## **DOSING NOZZLES** (used to control chemical draw)

ST-160 Injector, ST-167 and ST-168 Bypass Injectors come with 10 dosing nozzle inserts. ST-164 & ST-166 Injectors come with 20 dosing nozzle inserts. ST-160.3A injector come with 30 dosing nozzle inserts. **Additional nozzles available.**

ORDER #	INJECTOR
200163340	For Chemical Injectors
200163335X	For <b>Extreme</b> Chemical Injectors

### Location of dosing nozzles on injectors

ST-160



ST-160.3A

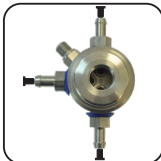

ST-164



ST-166

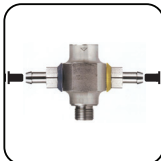

ST-167/ST-168



## **DOSING NOZZLES DILUTION RATIOS**

The chart below shows dosing nozzle size. The percentage of draw may vary, because of the chemical viscosity.

Dosing Nozzle Size	% Chemical Draw	Ratio
0.5	0.5%	200:1
0.6	0.8%	125:1
0.7	1.0%	100:1
1.0	2.5%	40:1
1.1	3.0%	33:1
1.2	4.0%	25:1
1.3	5.0%	20:1
1.5	8.0%	12.5:1
1.7	9.0%	11.25:1
2.0	10.0%	10:1

The size of each dosing nozzle is marked on the lip of the individual nozzle

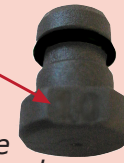

Simply press the dosing nozzle into the barb as illustrated

**\*Not sold individually.**

## **EXTREME DOSING NOZZLES** (stainless steel)

**NEW!**



ORDER #	NOZZLE SIZE (MM)
040004705	0.5 mm
040004706	0.6 mm
040004707	0.7 mm
040004708	0.8 mm
040004709	0.9 mm
040004710	1.0 mm
040004711	1.1 mm
040004712	1.2 mm
040004713	1.3 mm
040004715	1.5 mm

- Sold individually, one per pack.
- Used to control chemical draw.

### **ALSO AVAILABLE:**

O-Ring: #050002335. Must purchase separately.

## ST-73 FOAMER

Convenient and portable for more effective foam cleaning for Industrial, Agriculture, Automotive/Fleet and Institutional applications.

ORDER #	PRESSURE	TEMP.	FLOW RATE	INLET	BOTTLE SIZE	WEIGHT
200073907	1000 - 4350 PSI	130° F	up to 5 GPM	1/4" F	32 oz	1.10 lb
200073906	1000 - 4350 PSI	130° F	up to 5 GPM	1/4" F	64 oz	1.20 lb

- 5 position metering valve for chemical draw.
- Stainless steel non-corrosive injector.
- Easy to fill wide mouth bottle with fill markings.
- Integrated injector (1.5 mm) (no additional injector required).

### ALSO AVAILABLE:

- 32 oz bottle only #020073513
- 64 oz bottle only #020073520

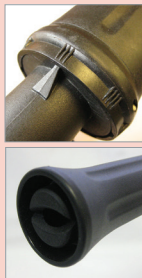

5 position metering valve

POSITION	DILUTION RATE
1	2 - 2.5%
2	4 - 4.5%
3	5 - 5.5%
4	6.5 - 7%
5	7.5 - 8%



See in action!

<https://www.youtube.com/watch?v=phQMxtrJFqk>

## ST-73H FOAMER (high volume)

ORDER #	PRESSURE	TEMP.	FLOW RATE	INLET	BOTTLE SIZE	WEIGHT
200073916	1000 - 4350 PSI	130° F	up to 8 GPM	1/4" F	64 oz	1.20 lb

- 5 position metering valve for chemical draw.
- Stainless steel non-corrosive injector.
- Easy to fill wide mouth bottle with fill markings.
- Integrated injector (1.8 mm) (no additional injector required).

### ALSO AVAILABLE:

- Bottle only currently available in 64 oz bottle #020073520



## SA-73 FOAMER

Simply fill bottle with detergent and attach to pressure washer gun or wand. Great item for all pressure washer cleaning applications.

ORDER #	PRESSURE	FLOW RATE	TEMP.	INLET	BOTTLE SIZE
400073700	1100 to 5000 PSI	2.0 to 5.3 GPM	140° F	1/4" F or QC plug	37 oz

- Adjustable spray pattern. Rotate black plastic nozzle housing to adjust spray pattern. The (+) means it allow more air; and (-) means it will allow less air to be mixed with the cleaning agent. By allowing more air to mix with the cleaning agent it will produces a rich type foam.
- Solid brass valve body.
- Perfect tool for the pressure washer cleaning enthusiast.
- Spraying range 15 ft to 20 ft.



Top View



# FOAMING: FOAM NOZZLES

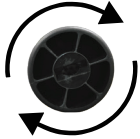

Easily change the spray pattern from vertical to horizontal



See in action!

<https://www.youtube.com/shorts/Wt4CSFziE40>

## ST-75 FOAM NOZZLES

Produces thick foam for an easy and safe application and to save on chemical usage by reducing splash and drift of chemicals in conjunction with Suttner injectors.

ORDER #	PRESSURE	TEMP.	ORIFICE	INJECTOR NOZZLE ONLY
200075548	5000 PSI	140° F	3.0	200075403
200075549	5000 PSI	140° F	4.0	200075404
200075552	5000 PSI	140° F	5.0	200075405
200075550	5000 PSI	140° F	5.5	200075455
200075551	5000 PSI	140° F	6.5	200075406
200075554	5000 PSI	140° F	8.0	200075408
200075553	5000 PSI	140° F	10.0	200075410
200075555	5000 PSI	140° F	13.0	200075413
200075556	5000 PSI	140° F	15.0	200075415
200075557	5000 PSI	140° F	20.0	200075420

FLOW RATE	INLET	WEIGHT
1 - 6 GPM	1/4" F	.31 lb

- Saves time and money.
- **Heavy duty.**
- Foam injector required.
- **Optimum foam created 130°F or less.**

**FOOD GRADE**



Easily change the spray pattern from vertical to horizontal

## ST-75S FOAM NOZZLES (stainless steel)

ST-75S produces thick foam for an easy and safe application and to save on chemical usage by reducing splash and drift of chemicals.

ORDER #	PRESSURE	TEMP.	ORIFICE	INJECTOR NOZZLE ONLY
200075574	5000 PSI	140° F	5.0	200075405
200075572	5000 PSI	140° F	8.0	200075408
200075573	5000 PSI	140° F	10.0	200075410
200075575	5000 PSI	140° F	13.0	200075413
200075576	5000 PSI	140° F	15.0	200075415
200075577	5000 PSI	140° F	20.0	200075420

FLOW RATE	INLET	WEIGHT
1 - 6 GPM	1/4" F	.31 lb

- With stainless steel "wool" like foam pad.
- Foam injector required.
- **Optimum foam created 130°F or less.**

# FOAMING: FOAM NOZZLES

## ST-75.2 LONG RANGE FOAM NOZZLES

ORDER #	PRESSURE	TEMP.	FLOW RATE	INLET	ORIFICE	WEIGHT
200075800065	2175 PSI	194° F	up to 7 GPM	1/4" FPT	6.5	.75 lb
200075800070	2175 PSI	194° F	up to 7 GPM	1/4" FPT	7.0	.75 lb
200075800075	2175 PSI	194° F	up to 7 GPM	1/4" FPT	7.5	.75 lb
200075800080	2175 PSI	194° F	up to 7 GPM	1/4" FPT	8.0	.75 lb
200075800100	2175 PSI	194° F	up to 7 GPM	1/4" FPT	10.0	.75 lb
200075800130	2175 PSI	194° F	up to 7 GPM	1/4" FPT	13.0	.75 lb
200075800150	2175 PSI	194° F	up to 7 GPM	1/4" FPT	15.0	.75 lb
200075810130	2175 PSI	194° F	up to 12 GPM	1/4" FPT	13.0	.75 lb
200075810150	2175 PSI	194° F	up to 12 GPM	1/4" FPT	15.0	.75 lb
200075810200	2175 PSI	194° F	up to 12 GPM	1/4" FPT	20.0	.75 lb

- 1/4" inlet.
- Adjustable airflow.
- Throws foam 40 feet.
- **Optimum foam created 130°F or less.**



<https://www.youtube.com/watch?v=UWh291UrNQk>

## ST-76 FOAM BLASTERS

Use for high volume applications.

ORDER #	PRESSURE	TEMP.	ORIFICE	INJECTOR NOZZLE ONLY
200076609	3625 PSI	194° F	3.0	200075403 (3)
200076612	3625 PSI	194° F	4.0	200075404 (3)
200076615	3625 PSI	194° F	5.0	200075405 (3)
200076616	3625 PSI	194° F	5.5	200075455 (3)
200076618	3625 PSI	194° F	6.5	200075406 (3)
200076621	3625 PSI	194° F	7.0	200075470 (3)
200076600	3625 PSI	194° F	7.5	200075407 (3)
200076624	3625 PSI	194° F	8.0	200075408 (3)
200076630	3625 PSI	194° F	10.0	200075410 (3)
200076639	3625 PSI	194° F	13.0	200075413 (3)
200076645	3625 PSI	194° F	15.0	200075415 (3)

FLOW RATE	INLET	WEIGHT
6 - 16 GPM	1/2" F	1.15 lb

- Stainless steel injector nozzle.
- Covers large areas.
- 50° x 200 mm orifice.
- Wider spray angle.
- Throws foam 40 feet.
- Foam injector required.
- For applications of 6 GPM or higher.
- **Optimum foam created 130°F or less.**



<https://www.youtube.com/watch?v=pCoizFgZakk>

# FOAMING: FOAM LANCES

## ST-175 FOAM LANCES (stainless steel)

With ST-58 change-over valve.



#200175420



#200175430



Use double nipple to attach accessories  
#57040 Brass  
#57049 S.S.  
(see page 115)

ORDER #	PRESSURE	ORIFICE	LENGTH	WEIGHT
200175420	5000 PSI	—	29 in.	2.70 lb
200175420403	5000 PSI	3.0	29 in.	2.70 lb
200175420404	5000 PSI	4.0	29 in.	2.70 lb
200175420405	5000 PSI	5.0	29 in.	2.70 lb
200175420455	5000 PSI	5.5	29 in.	2.70 lb
200175420406	5000 PSI	6.5	29 in.	2.70 lb
200175420470	5000 PSI	7.0	29 in.	2.70 lb
200175420407	5000 PSI	7.5	29 in.	2.70 lb
200175420408	5000 PSI	8.0	29 in.	2.70 lb
200175420410	5000 PSI	10.0	29 in.	2.70 lb
200175420413	5000 PSI	13.0	29 in.	2.70 lb
200175420415	5000 PSI	15.0	29 in.	2.70 lb
200175420420	5000 PSI	20.0	29 in.	2.70 lb
200175430	5000 PSI	—	47 in.	3.65 lb
200175430403	5000 PSI	3.0	47 in.	3.65 lb
200175430404	5000 PSI	4.0	47 in.	3.65 lb
200175430405	5000 PSI	5.0	47 in.	3.65 lb
200175430455	5000 PSI	5.5	47 in.	3.65 lb
200175430406	5000 PSI	6.5	47 in.	3.65 lb
200175430470	5000 PSI	7.0	47 in.	3.65 lb
200175430407	5000 PSI	7.5	47 in.	3.65 lb
200175430408	5000 PSI	8.0	47 in.	3.65 lb
200175430410	5000 PSI	10.0	47 in.	3.65 lb
200175430413	5000 PSI	13.0	47 in.	3.65 lb
200175430415	5000 PSI	15.0	47 in.	3.65 lb
200175430420	5000 PSI	20.0	47 in.	3.65 lb

TEMP.	FLOW RATE	INLET
212° F	1-6 GPM	1/4" F

- Lance only #200175420 & #200175430.
- All other part numbers listed above include the foam nozzle.
- Stainless steel components.
- Vented grip lance.
- 1/4" turn for foam to rinse.



Twist for foam or rinse

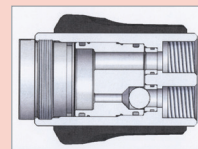

Internal view



Vented grip handle



See in action!

[https://youtu.be/LKN\\_XEPSR3c](https://youtu.be/LKN_XEPSR3c)

# FOAMING: FOAM LANCES & FOAM BRUSH

## ST-176 FOAM LANCES (stainless steel)

With ST-58 change-over valve.

ORDER #	PRESSURE	ORIFICE	LENGTH	WEIGHT
200176410	3625 PSI	—	27.5 in.	3.45 lb
200176609	3625 PSI	9.0	27.5 in.	3.45 lb
200176615	3625 PSI	15.0	27.5 in.	3.45 lb
200176619	3625 PSI	19.5	27.5 in.	3.45 lb
200176630	3625 PSI	30.0	27.5 in.	3.45 lb

  

TEMP.	FLOW RATE	INLET
212° F	6-16 GPM	1/4" F

- Stainless steel components.
- Vented grip lance.
- 1/4" turn for foam to rinse.
- **Injector nozzle sold separately.**



Twist for foam or rinse

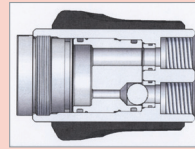

Internal view



Vented grip handle

### ALSO AVAILABLE:

ST-58 Change-Over Valve

ORDER #	PRESSURE	TEMP.	INLET	WEIGHT
200058600	5000 PSI	200° F	1/4" FPT	.85 lb

- Stainless steel.
- No roll-over nozzle.
- Corrosive resistant.



Use double nipple to attach accessories #57040 Brass #57049 S.S. (see page 115)

## TURBO FOAM BRUSH

Foam like your at a car wash, brush bristles made from Chinese Highland Hogs, soft for delicate surfaces.

ORDER #	PRESSURE	TEMP.	INLET	FLOW RATE	ORIFICE	WEIGHT
200023710040	2200 PSI	122° F	1/4" FPT	6 GPM	4.0	1.35 lb
200023710080	2200 PSI	122° F	1/4" FPT	6 GPM	8.0	1.35 lb
200023710100	2200 PSI	122° F	1/4" FPT	6 GPM	10.0	1.35 lb
200023710130	2200 PSI	122° F	1/4" FPT	6 GPM	13.0	1.35 lb

- Increases volume of foam without changing chemical intake.
- Reduces chemical intake without changing foam consistency.



<https://www.youtube.com/watch?v=0xZrSYxRO00&t=37s>

# FOAMING: FOAM JET & FOAM LANCES

**NEW!**



## ECS Jet

- High pressure injector with long throw.
- Various nozzle sizes and dosages available.
- Apply soap and rinse with the same nozzle.
- Chemicals do not run through pump, hoses, spray gun or lance.
- Adjustable spray pattern.

## ST-72 FOAM LANCES

*Air injector nozzle creates pressure.*



ORDER #	PRESSURE	TEMP.	ORIFICE	INLET	LENGTH	WEIGHT	COLOR
200072500	3625 PSI	130° F	9.5	1/4" M	23.5"	1.95 lb	Green
200072600	3625 PSI	130° F	9.5	1/4" M	47.25"	2.45 lb	Green
200072510	3625 PSI	130° F	13.0	1/4" M	23.5"	1.95 lb	Yellow
200072610	3625 PSI	130° F	13.0	1/4" M	47.25"	2.45 lb	Yellow
200072525	3625 PSI	130° F	22.0	1/4" M	23.5"	1.95 lb	Blue
200072526	3625 PSI	130° F	22.0	1/4" M	47.25"	2.45 lb	Blue
200072520	3625 PSI	130° F	25.0	1/4" M	23.5"	1.95 lb	Red
200072620	3625 PSI	130° F	25.0	1/4" M	47.25"	2.45 lb	Red

- Stainless steel with vented handle grip.
- **Optimum foam created 130°F or less.**

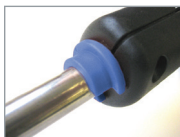

Orifice Indicator located on lance



Vented grip handle

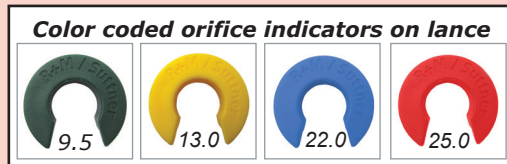

## ST-72F FOAM LANCES

*Air injector nozzle creates pressure.*



ORDER #	PRESSURE	TEMP.	ORIFICE	INLET	LENGTH	WEIGHT	COLOR
200072630	3625 PSI	130° F	9.5	1/4" MPT	23.5"	1.50 lb	Green
200072635	3625 PSI	130° F	13.0	1/4" MPT	23.5"	1.50 lb	Yellow
200072641	3625 PSI	130° F	22.0	1/4" MPT	23.5"	1.50 lb	Blue

- Stainless steel with vented handle grip.
- Foam injector not required (consult tech support).
- **Optimum foam created 130°F or less.**



Orifice Indicator located on lance



Vented grip handle



# FOAMING: ACCESSORIES

## ST-3100 COUPLINGS (stainless steel)

ORDER #	PRESSURE	TEMP.	DESCRIPTION	WEIGHT
203100457	5000 PSI	302° F	1/2" FPT	.35 lb
203100656	5000 PSI	302° F	1/2" MPT	.35 lb

- High pressure couplings.

### ALSO AVAILABLE:

Replacement O-rings (two o-rings required)

ORDER #	SIZE
050000660	18 x 2
050000670	15.1 x 2.7

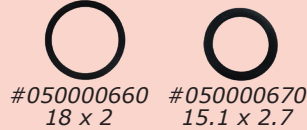

**FOOD  
GRADE**



#203100457 #203100656

## ST-3100 PLUGS (stainless steel)

ORDER #	PRESSURE	TEMP.	DESCRIPTION	WEIGHT
040005665	5000 PSI	302° F	1/4" FPT Plug	.16 lb
040005661	5000 PSI	302° F	1/2" FPT Plug	.16 lb
040005662	5000 PSI	302° F	1/4" MPT Plug	.16 lb
040005659	5000 PSI	302° F	1/2" MPT Plug	.16 lb

- High pressure plugs.

**FOOD  
GRADE**



#040005659 #040005661



#040005662 #040005665

## ST-75 REPLACEMENT SCREEN & PAD

ORDER #	DESCRIPTION
020000606	ST-75 replacement screen
040073503	ST-75 replacement pad



Place the mesh  
into the nozzle  
(folded end first)



#020000606



#040073503

## REDUCING BUSHINGS (stainless steel)

ORDER #	PRESSURE	TEMP.	DESCRIPTION	WEIGHT
57559	5000 PSI	300° F	3/8" F x 1/2" M	.08 lb

**FOOD  
GRADE**



## DOUBLE NIPPLE (stainless steel)

ORDER #	PRESSURE	TEMP.	DESCRIPTION	WEIGHT
57049	5000 PSI	300° F	1/4" M x 1/4" M	.08 lb

**FOOD  
GRADE**



## DOUBLE NIPPLE (brass)

ORDER #	PRESSURE	TEMP.	DESCRIPTION	WEIGHT
57040	4000 PSI	300° F	1/4" M x 1/4" M	.08 lb



## REDUCING NIPPLE (stainless steel)

ORDER #	PRESSURE	TEMP.	DESCRIPTION	WEIGHT
57549	5000 PSI	300° F	1/2" M x 1/4" F	.08 lb



# FOAMING: FOAM ACCESSORIES



## FOAM INJECTOR TWO COMPONENT INLET *(stainless steel)*

**ORDER #**  
200164355

- Easily connects to all chemical intake injectors.
- Swiveling Inlet.
- FEPM seals as standard.

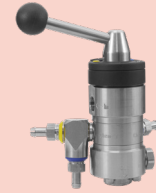

*Shown here with injector-not included*

**FOOD GRADE**



## ST-161 METERING VALVE *(stainless steel)*

ORDER #	TEMP.	HOSE BARB	WEIGHT
200161500	212° F	.35"	1.75 lb

- Fits foam injectors: ST-160, ST-164, ST-166, ST-167 and ST-168.
- Eliminates the need for dosing nozzles.
- Adjustable.



*Easy to read dial*

**FOOD GRADE**



## ST-161 STOP NUT *(stainless steel)*

**ORDER #**  
040003566

- Preset dosing valve and replace dial with stop nut so it can't be adjusted.

**FOOD GRADE**



## ST-32 CHEMICAL STRAINER *(stainless steel)*

*Soap enters through strainer preventing debris from entering the pump. A durable alternative to lightweight strainers.*

ORDER #	HOSE BARB	MATERIAL	WEIGHT
200032600	5/16" or 3/8"	Stainless Steel	.06 lb

- Chemical resistant plastic screen outperforms stainless steel screens.
- Straight through design.
- 4 ft clear hose available, #900000041.



## NYLON HOSES *(reinforced pvc)*

ORDER #	TEMP.	I.D.	COLOR
080000004	140° F	.35"	Clear (universal)
080000310	140° F	.35"	Blue (foam)
080000320	140° F	.35"	Yellow (disinfectant)

- Reinforced with (5) layers of PVC.
- Price per foot (available in any length).

# **PRESSURE WASHER ACCESSORIES**

FLOW SWITCHES:	118
PRESSURE SWITCH:	119
UNLOADERS:	120
SOCKETS & PLUGS:	124
SWIVELS:	128
SCREW COUPLERS:	131
SCREW NIPPLES:	132
BREAK AWAY FITTINGS, ADAPTER BUSHING & BAYONETS.....	134
VALVES.....	135
STRAINERS.....	137
CHEMICAL INJECTORS.....	138
MISCELLANEOUS ACCESSORIES.....	139



# FLOW SWITCHES



## **ST-5 FLOW SWITCH (brass housing, 4380 psi)**

Vertical mounting position and free floating brass magnet configuration.

ORDER #	PRESSURE	TEMP.	FLOW RATE
200005542	75 - 4380 PSI	176° F	1.0 - 8.0 GPM

INLET	OUTLET	WEIGHT	BOX QTY
3/8" FPT	3/8" FPT	.98 lb	25

Replacement reed switch: #200005435

Replacement float: #200005519

- Mounts further downstream in pumping system than traditional vacuum switches, thereby minimizing potential leak points that can cause vacuum switches to close.
- Easy brass reed switch replacement.
- **Visit our website to view manual and part lists.**

## **5075 PSI**



## **ST-5 FLOW SWITCH (brass housing, 5075 psi)**

Mounts in **any position** with a free floating magnet configuration.

ORDER #	PRESSURE	TEMP.	FLOW RATE
200005601	75 - 5075 PSI	176° F	1.0 - 7.8 GPM

INLET	OUTLET	WEIGHT	BOX QTY
3/8" FPT	3/8" FPT	.98 lb	25

Replacement reed switch: #200005435

Replacement float: #200005519

- Mounts further downstream in pumping system than traditional vacuum switches, thereby minimizing potential leak points that can cause vacuum switches to close.
- Easy brass reed switch replacement.
- **Visit our website to view manual and part lists.**

## **HIGH Flow**



## **ST-5 FLOW SWITCH (brass housing, high flow)**

Mounts in **any position** with a free floating magnet configuration

ORDER #	PRESSURE	TEMP.	FLOW RATE
200005711	75 - 3046 PSI	176° F	4 - 16 GPM

INLET	OUTLET	WEIGHT	BOX QTY
1/2" FPT	1/2" FPT	.98 lb	25

Replacement reed switch: #200005435

Replacement float: #200005528

- Mounts further downstream in pumping system than traditional vacuum switches, thereby minimizing potential leak points that can cause vacuum switches to close.
- Easy brass reed switch replacement.
- **Visit our website to view manual and part lists.**



## **ST-6 FLOW SWITCH (brass housing, 4500 psi)**

Mounts in **any position** and spring assisted brass magnet configuration.

ORDER #	PRESSURE	TEMP.	FLOW RATE
200006703	75 - 4500 PSI	176° F	1.0 - 8.0 GPM

INLET	OUTLET	WEIGHT	BOX QTY
3/8" MPT	3/8" MPT	.80 lb	50

Replacement reed switch: #200005435

Replacement float: #200006490

- Mounts further downstream in pumping system than traditional vacuum switches, thereby minimizing potential leak points that can cause vacuum switches to close.
- Easy brass reed switch replacement.
- Can be mounted horizontal or vertical.
- **Visit our website to view part lists.**

# FLOW SWITCHES & PRESSURE SWITCHES

## ST-7 FLOW SWITCHES (with micro switch)

Mounts in **any position** and spring assisted brass magnet configuration.

ORDER #	PRESSURE	TEMP.	WEIGHT	SWITCH POINT
200007500	75 - 5000 PSI	176° F	.80 lb	1.2 GPM
200007510	75 - 5000 PSI	176° F	.80 lb	0.3 GPM
<b>NEW!</b> 2000075xx	75 - 7200 PSI	176° F	2.55 lb	1.2 GPM
INLET	OUTLET	FLOW RATE	BOX QTY	
3/8" FPT	3/8" FPT	12 GPM	50	

Replacement micro switch: #200007498

#200007500 replacement float: #200007497

#200007510 replacement float: #200007496

- With micro-switch instead of reed switch.
- Easy to install.
- Resistant against shock and vibration.
- IP 65 rated-water and dust proof.
- Can be wired normally opened or closed.



**7200 PSI**

**NEW!**



Stainless Steel

## ST-505 FLOW SWITCH (stainless steel, 8700 psi)

Vertical mounting position and free floating brass magnet configuration.

ORDER #	PRESSURE	TEMP.	FLOW RATE
200505706	75 - 8700 PSI	180° F	1.0 - 7.8 GPM
INLET	OUTLET	WEIGHT	BOX QTY
3/8" FPT	3/8" FPT	.90 lb	50

Replacement reed switch: #200005435

Replacement float: #200005300

- Mounts further downstream in pumping system than traditional vacuum switches, thereby minimizing potential leak points that can cause vacuum switches to close.
- Easy brass reed switch replacement.
- **3/8" bonded seal #78888389 is recommended to seal inlet and outlet threads.**
- **Visit our website to view manual and part lists.**

**8700 PSI**



## ST-7.1 PRESSURE SWITCHES

ORDER #	PRESSURE	TEMP.	SWITCH POINT	INLET	COLOR
200007800	4350 PSI	190° F	580 PSI	1/4" MPT	Black
200007801	4350 PSI	190° F	360 PSI	1/4" MPT	Red

- Compact design.
- Split piston for water and electrical side.
- Easy to install.
- IP 65 rated-water and dust proof.
- Can be wired normally opened or closed.
- Max 10 Amps Rating.



**47" wire**

# UNLOADERS

## **SUTTNER'S UNLOADER VALVES FEATURES:**

- Working components constructed of high-grade stainless steel.
- PTFE and Viton seals for maximum heat and chemical resistance.
- Straight flow-through design minimizes pressure loss through valve.
- Adjustable valve allows limit setting on both maximum and minimum pressures.
- Internal bypass valve can be easily accessed and repaired .
- without removing unloader from unit.
- **Visit our website to view manuals and part lists.**



### **ST-261 UNLOADER VALVE** (pressure compensating)

ORDER #	PRESSURE	TEMP.	FLOW RATE	INLET
200261500	500 - 3625 PSI	176° F	8 GPM	3/8" FPT
OUTLET	BYPASS	WEIGHT	BOX QTY	
3/8" FPT	1/4" FPT	1.34 lb	25	

Spring for  
#200261504



### **ST-261C UNLOADER VALVE** (pressure compensating)

Lower PSI setting. **Ideal for carpet cleaners.**

ORDER #	PRESSURE	TEMP.	FLOW RATE	INLET
200261504	200 - 1000 PSI	176° F	8 GPM	3/8" FPT
OUTLET	BYPASS	WEIGHT	BOX QTY	
3/8" FPT	1/4" FPT	1.34 lb	25	

**Repair Kits:**

Valve #200261526  
Bypass #200261528



### **ST-261T UNLOADER VALVE**

(tamperproof and **pressure compensating**)

Allows you to preset unloader and glue on cover so it can't be readjusted. **Ideal for rental machines.**

ORDER #	PRESSURE	TEMP.	FLOW RATE	INLET
200261503	200 - 1000 PSI	176° F	8 GPM	3/8" FPT
OUTLET	BYPASS	WEIGHT	BOX QTY	
3/8" FPT	1/4" FPT	1.34 lb	25	

**Repair Kits:**

Valve #200261526  
Bypass #200261528  
Replacement Cap #020000277

- Great for rental machines.



### **COMPLETE REPLACEMENT MICRO SWITCH**

For ST-261, ST-261I, ST-261S & ST-261SI

ORDER #
200260513

- Can be installed onto the ST-261.
- Normally open in bypass.

## ST-261I UNLOADER VALVES

*(With chemical injector and pressure compensating)*

*Built-in exclusive down stream (venturi-type) injector with built in orifice provides more precise siphon rate*

ORDER #	PRESSURE	INJECTOR FLOW RATE	ORIFICE	TEMP.
200261560	500 - 3625 PSI	1.50-2.25 GPM	1.8 mm	176° F
200261570	500 - 3625 PSI	2.25-3.35 GPM	2.1 mm	176° F
200261580	500 - 3625 PSI	3.35-5.00 GPM	2.4 mm	176° F

BYPASS	FLOW RATE	INLET	OUTLET	WEIGHT
1/4" FPT	8 GPM	3/8" FPT	3/8" FPT	1.40 lb

Repair Kits: Valve #200261526  
 Bypass #200261528  
 Injector #200060720

- Convenient downstream built-in chemical injector.



## ST-261S UNLOADER VALVE

*(With micro-switch and pressure compensating)*

ORDER #	PRESSURE	TEMP.	FLOW RATE	INLET
200261550	500 - 3625 PSI	176° F	8 GPM	3/8" FPT

OUTLET	BYPASS	WEIGHT	BOX QTY
3/8" FPT	1/4" FPT	1.82 lb	25

Repair Kits: Valve #200261526  
 Bypass #200261528  
 Switch Kit #200261527

- Normally open in bypass.



## ST-261SI UNLOADER VALVES

*(With micro-switch & chemical injector and pressure compensating)*

ORDER #	PRESSURE	INJECTOR FLOW RATE	ORIFICE	TEMP.
200261561	500 - 3625 PSI	1.50-2.25 GPM	1.8 mm	176° F
200261571	500 - 3625 PSI	2.25-3.35 GPM	2.1 mm	176° F
200261581	500 - 3625 PSI	3.35-5.00 GPM	2.4 mm	176° F

BYPASS	FLOW RATE	INLET	OUTLET	WEIGHT
1/4" FPT	8 GPM	3/8" FPT	3/8" FPT	1.85 lb

Repair Kits: Valve #200261526  
 Bypass #200261528  
 Switch Kit #200261527  
 Injector #200260720

- Convenient downstream built-in chemical injector.
- Normally open in bypass.



# UNLOADERS



#200265500

## ST-265 UNLOADER VALVE (pressure compensating)

ORDER #	PRESSURE	TEMP.	FLOW RATE
200265500	1000 - 5070 PSI	176° F	13 GPM
INLET	OUTLET	BYPASS	WEIGHT
3/8" FPT	3/8" FPT	3/8" FPT	2.10 lb

## ST-265S UNLOADER VALVE (pressure compensating) (with switch)

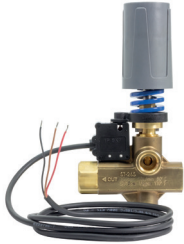

#200265550

ORDER #	PRESSURE	TEMP.	FLOW RATE
200265550	1000 - 5070 PSI	176° F	13 GPM
INLET	OUTLET	BYPASS	WEIGHT
3/8" FPT	3/8" FPT	3/8" FPT	2.10 lb

- Equipped with a ball check valve.
- Fatigue-free spring.
- Valve components made of high-grade stainless steel and ceramic.
- Repair Kit: #200265430

**NEW!**

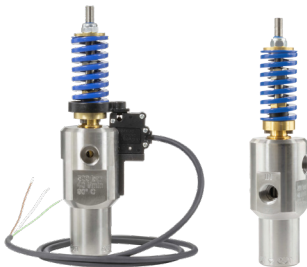

#200275550 with switch #200275500

## ST-275 UNLOADER VALVES (7250 psi)

ORDER #	PRESSURE	TEMP.	FLOW RATE	WEIGHT
200275550	7250 PSI	194° F	10.5 GPM	2.73 lb
200275500	7250 PSI	194° F	10.5 GPM	2.86 lb
INLET	OUTLET	BYPASS		
3/8" FPT	1/2" FPT	3/8" FPT		

Repair Kit: #200265430

## ST-280 UNLOADER VALVE (4060 psi)



ORDER #	PRESSURE	TEMP.	FLOW RATE	INLET
200280510	500 - 4060 PSI	176° F	8 GPM	3/8" FPT
OUTLET	BYPASS	WEIGHT	BOX QTY	
3/8" FPT	1/4" FPT	1.80 lb	20	

Repair Kits: #200280646  
#200280530  
#200280650

- Multi gun operational.



## ST-280.2 UNLOADER VALVE (with 2 bypass plugs, 4060 psi)

ORDER #	PRESSURE	TEMP.	FLOW RATE	INLET
200280511	500 - 4060 PSI	176° F	8 GPM	3/8" FPT
OUTLET	BYPASS	WEIGHT		
3/8" FPT	1/4" FPT	1.80 lb		

Repair Kits: #200280646  
#200280530  
#200280650

- Multi gun operational.

## ST-285 UNLOADER VALVES (high flow)

ORDER #	PRESSURE	TEMP.	FLOW RATE	WEIGHT
200285550	3600 PSI	194° F	26 GPM	2.10 lb
200285500	3600 PSI	194° F	26 GPM	2.10 lb

INLET	OUTLET	BYPASS
1/2" FPT	1/2" FPT	1/2" FPT

Repair Kit: #200265430

- High-quality combination of materials.
- Fatigue-free spring.
- Sealing seats in high grade stainless steel and ceramic ball in bypass.

**NEW!**



#200285500



#200285550  
with switch

## ST-291 UNLOADER VALVE (5070 psi)

ORDER #	PRESSURE	TEMP.	FLOW RATE	INLET
200291500	850 - 5070 PSI	194° F	8 GPM	3/8" FPT

OUTLET	BYPASS	WEIGHT	BOX QTY
3/8" FPT	1/2" FPT	2.60 lb	15

Repair Kits: Seal Seat #200291485

Check Valve #200291490

Piston Rod #200291495



## REPLACEMENT PARTS:

### REPLACEMENT SWITCH

For ST-265

**ORDER #**  
200265430



### PANEL MOUNT NUT

For ST-261, ST-261I,  
ST-261S & ST-261SI

**ORDER #** | **MATERIAL**  
010003150 | Brass



- Threads onto unloader for mounting to panel.

# SOCKETS & PLUGS

#200045711



#200045701

## ECONOMY Q.C. BRASS SOCKET (quick change)

ORDER #	PRESSURE	DESCRIPTION	O-RING	BAG QTY	WEIGHT
200045701	5500 PSI	1/4" MPT Socket	Buna	10	.16 lb
200045711	5500 PSI	1/4" FPT Socket	Buna	10	.18 lb
200045721	4200 PSI	3/8" MPT Socket	Buna	10	.24 lb
200045731	4200 PSI	3/8" FPT Socket	Buna	10	.26 lb
200045751	3600 PSI	1/2" FPT Socket	Buna	10	.34 lb
200045751M	3600 PSI	1/2" MPT Socket	Buna	10	.40 lb

- Interchanges easily with Suttner products and other major brands.
- Knurling on socket sleeve helps to grip ball lock.
- Pedal and valve are in protective housing.

**Comparable rated components must be used together**

#1000BR151



#1000BR141

## ECONOMY Q.C. PLUGS (brass)

ORDER #	PRESSURE	DESCRIPTION	BAG QTY	WEIGHT
1000BR141	5200 PSI	1/4" M Plug	10	.06 lb
1000BR151	5200 PSI	1/4" F Plug	10	.07 lb
1000BR161	2800 PSI	3/8" M Plug	10	.08 lb
1000BR171	2800 PSI	3/8" F Plug	10	.10 lb

**Comparable rated components must be used together**

#100000141



#100000151

## ECONOMY Q.C. PLUGS (plated steel)

ORDER #	PRESSURE	DESCRIPTION	BAG QTY	WEIGHT
100000141	5500 PSI	1/4" MPT Plug	25	.06 lb
100000151	5500 PSI	1/4" FPT Plug	25	.06 lb
100000161	4200 PSI	3/8" MPT Plug	25	.08 lb
100000171	4200 PSI	3/8" FPT Plug	25	.12 lb
100000181	3600 PSI	1/2" M Plug	25	.14 lb
100000191	3600 PSI	1/2" F Plug	25	.18 lb

**Comparable rated components must be used together**

#20SS45711



#20SS45701

## ECONOMY Q.C. STAINLESS STEEL SOCKETS

ORDER #	PRESSURE	DESCRIPTION	O-RING	BAG QTY	WEIGHT
20SS45701	7500 PSI	1/4" M Socket	Buna	10	.22 lb
20SS45711	7500 PSI	1/4" F Socket	Buna	10	.16 lb
20SS45721	6300 PSI	3/8" M Socket	Buna	10	.22 lb
20SS45731	6300 PSI	3/8" F Socket	Buna	10	.24 lb
20SS45746	3600 PSI	1/2" MPT Socket	Buna	10	.32 lb
20SS45751	3600 PSI	1/2" FPT Socket	Buna	10	.35 lb

**Comparable rated components must be used together**

## ECONOMY Q.C. STAINLESS STEEL PLUGS

ORDER #	PRESSURE	DESCRIPTION	BAG QTY	WEIGHT
1000SS141	7500 PSI	1/4" M Plug	25	.06 lb
1000SS151	7500 PSI	1/4" F Plug	25	.06 lb
1000SS161	6300 PSI	3/8" M Plug	25	.08 lb
1000SS171	6300 PSI	3/8" F Plug	25	.12 lb
1000SS181	3600 PSI	1/2" M Plug	25	.16 lb
1000SS191	3600 PSI	1/2" F Plug	25	.18 lb



**Comparable rated components must be used together**

## Q.C. BRASS SOCKETS (quick change)

Couplers are used anywhere high pressure connections are frequently connected and disconnected. Ideal for quick change of quick nozzles and spray guns.

ORDER #	EATON #	PRESSURE	DESCRIPTION	O-RING	BOX QTY	WEIGHT
200045700	2S-15	5500 PSI	1/4" MPT Socket	Buna	200	.16 lb
200045710	2S-16	5500 PSI	1/4" FPT Socket	Buna	200	.16 lb
200045720	2S-20	4200 PSI	3/8" MPT Socket	Buna	125	.24 lb
200045730	2S-21	4200 PSI	3/8" FPT Socket	Buna	125	.26 lb
200045750M	4-S25	3600 PSI	1/2" MPT Socket	Buna	75	.34 lb
200045750	4S-26	3600 PSI	1/2" FPT Socket	Buna	75	.40 lb
200045760	6S-31	2100 PSI	3/4" FPT Socket	Buna	—	.64 lb



- Knurling on socket sleeve helps to grip ball lock.
- Eaton quick couplers are the original, invented in 1915 and are still the number one name for quality couplers.
- Interchanges easily with Suttner products and other major brands.

**Comparable rated components must be used together**

## Q.C. PLUGS (brass)

ORDER #	EATON #	PRESSURE	DESCRIPTION	BOX QTY	WEIGHT
1000BR140	B2T-15	5200 PSI	1/4" MPT Plug	25	.06 lb
1000BR151	B2T-16	5200 PSI	1/4" FPT Plug	25	.07 lb
1000BR160	B3T-20	2800 PSI	3/8" MPT Plug	25	.08 lb
1000BR170	B3T-21	2800 PSI	3/8" FPT Plug	25	.10 lb
1000BR200	B6T-30	1700 PSI	3/4" MPT Plug	25	.25 lb
1000BR210	B6T-31	1700 PSI	3/4" FPT Plug	25	.24 lb



**Comparable rated components must be used together**

## Q.C. PLUGS (plated steel)

ORDER #	EATON #	PRESSURE	DESCRIPTION	BAG QTY	WEIGHT
100000140	2T-15	5500 PSI	1/4" MPT Plug	25	.06 lb
100000150	2T-16	5500 PSI	1/4" FPT Plug	25	.06 lb
100000160	3T-20	4200 PSI	3/8" MPT Plug	25	.08 lb
100000170	3T-21	4200 PSI	3/8" FPT Plug	25	.12 lb
100000180	4T-25	3600 PSI	1/2" MPT Plug	25	.14 lb
100000190	4T-26	3600 PSI	1/2" FPT Plug	25	.18 lb



**Comparable rated components must be used together**

# SOCKETS & PLUGS



#20SS45700



#20SS45710

## Q.C. STAINLESS STEEL SOCKETS (303 stainless steel)

Couplers are used anywhere high pressure connections are frequently connected and disconnected. Ideal for quick change of quick nozzles and spray guns.

ORDER #	EATON #	PRESSURE	DESCRIPTION	O-RING	BAG QTY	WEIGHT
20SS45700	LL2-S15	7500 PSI	1/4" MPT Socket	Buna	200	.22 lb
20SS45710	LL2-S16	7500 PSI	1/4" FPT Socket	Buna	200	.16 lb
20SS45720	LL3-S20	6300 PSI	3/8" MPT Socket	Buna	125	.22 lb
20SS45730	LL3-S21	6300 PSI	3/8" FPT Socket	Buna	125	.24 lb
20SS45745	LL4-S26	3600 PSI	1/2" MPT Socket	Buna	75	.32 lb
20SS45750	LL4-S25	3600 PSI	1/2" FPT Socket	Buna	75	.35 lb

- Knurling on socket sleeve helps to grip ball lock.
- Eaton quick couplers are the original, invented in 1915 and are still the number one name for quality couplers.
- Interchanges easily with Suttner products and other major brands.

**Comparable rated components must be used together**



#1000SS150



#1000SS140

## Q.C. PLUGS (303 stainless steel)

ORDER #	EATON #	PRESSURE	DESCRIPTION	BAG QTY	WEIGHT
1000SS140	LL2-T15	7500 PSI	1/4" MPT Plug	25	.06 lb
1000SS150	LL2-T16	7500 PSI	1/4" FPT Plug	25	.06 lb
1000SS160	LL3-T20	6300 PSI	3/8" MPT Plug	25	.08 lb
1000SS170	LL4-T20	6300 PSI	3/8" FPT Plug	25	.12 lb
1000SS180	LL4-T25	3600 PSI	1/2" MPT Plug	25	.16 lb
1000SS190	LL4-T26	3600 PSI	1/2" FPT Plug	25	.18 lb

**Comparable rated components must be used together**



#100SSS170



#100SSS160

## Q.C. PLUGS (416 stainless steel)

ORDER #	EATON #	PRESSURE	DESCRIPTION	BAG QTY	WEIGHT
100SSS160	HL3T-20	6300 PSI	3/8" MPT Plug	25	.08 lb
100SSS170	HL3T-21	6300 PSI	3/8" FPT Plug	25	.10 lb

**Comparable rated components must be used together**

## HYDRO EXCAVATION SOCKETS (with locking feature)

- Easily lock socket in place by twisting it.
- Available sizes:
  - 1/4" M
  - 1/4" F
  - 3/8" M
  - 3/8" F
  - 1/2" M
  - 1/2" F

**NEW!**



*In locked position*

## TWO-WAY CHECK VALVES PLUGS (quick change)

ORDER #	EATON #	PRESSURE	DESCRIPTION	MATERIAL	WEIGHT
10TWSS170	LL3-K21	3700 PSI	3/8" FPT Plug	303 Stainless	.44 lb



## SOCKET REPLACEMENT O-RINGS

	ORDER #	DESCRIPTION	TEMP.	BAG QTY
<b>A</b>	900000210	1/4" Buna O-ring	250° F	100
<b>B</b>	900000200	1/4" EPDM O-ring	300° F	100
<b>C</b>	900000202	1/4" Silicon O-ring	400° F	100
<b>D</b>	900000211	3/8" Buna O-ring	250° F	100
<b>E</b>	900000201	3/8" EPDM O-ring	300° F	100
<b>F</b>	900000203	3/8" Silicon O-ring	400° F	100
<b>G</b>	900000212	1/2" Buna O-ring	250° F	100

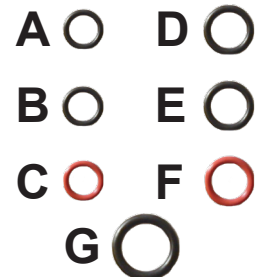

- For standard use part # 900000210, # 900000211 or 900000212.
- For broad chemical range use part # 900000200 or 900000201.
- For steam and high temperatures use part # 900000202 or 900000203.

# SWIVELS



## ST-96 SWIVEL (stainless steel)

ORDER #	PRESSURE	TEMP.	FLOW RATE	INLET	OUTLET
200096600	5000 PSI	212° F	10.5 GPM	3/8" FPT	3/8" MPT

- Tungsten Carbide Seals.

## ST-301 SWIVEL COUPLINGS (long life)

Professional spray gun swivel. Redesigned with the addition of a side bearing that increases swivel life by as much as TEN TIMES

ORDER #	TEMP.	INLET	OUTLET	WEIGHT
200301006	300° F	3/8" FPT	1/4" FPT	.20 lb
200301025	300° F	3/8" MPT	3/8" FPT	.29 lb
200301030	300° F	3/8" FPT	3/8" FPT	.27 lb

PRESSURE	FLOW RATE	BAG QTY.
5070 PSI	12 GPM	100

- Nickel plated, stainless steel internal.
- Double PTFE slide rings for easy movement.
- High performance plastic axial and radial slide bearing.
- Bearing material: PTFE/Bronze.
- RPM: 30.

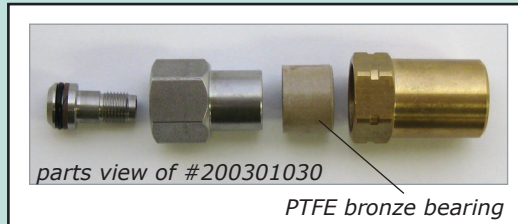

#200301006



#200301025

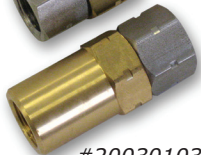
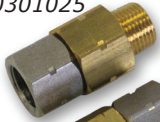

#200301030

**NEW!**



## ST-303 SWIVELS

Our dual bearing inner shaft design delivers consistent rotation even at high pressures. Designed to be used as high-pressure swivel that easily attaches to spray guns, hose connections, hydraulics, and other tangle-free applications.

ORDER #	PRESSURE	TEMP.	FLOW RATE	INLET	OUTLET	WEIGHT
200303214	4000 PSI	250° F	12 GPM	1/4" MPT	1/4" FPT	.30 lb
200303238	4000 PSI	250° F	12 GPM	3/8" MPT	3/8" FPT	.30 lb

- Swivel is made of stainless steel and nickel-plated brass for corrosion resistance and longevity.
- Constructed of corrosion-resistant materials.
- Dual bearing system.
- Good for chemicals with a pH range of 3 to 12.

## ST-310 SWIVEL COUPLINGS *(stainless steel)*

Perfect for hose connection to trigger guns, booms, etc.  
Prevents hose from tangling or twisting.

ORDER #	PRESSURE	TEMP.	FLOW RATE	INLET	OUTLET	BAG QTY.	WEIGHT
200310050	5000 PSI	300° F	12 GPM	3/8" MPT	3/8" FPT	100	.20 lb

- Extends the life of your hose.
- Double PTFE slide rings for easy movement.
- Axial and radial slide bearing.
- Bearing material: PTFE.
- RPM: 30.



## ST-311 SWIVEL COUPLINGS *(stainless steel)*

Perfect for hose connection to trigger guns, booms, etc.  
Prevents hose from tangling or twisting.

ORDER #	PRESSURE	TEMP.	FLOW RATE	INLET	OUTLET	BAG QTY.	WEIGHT
200311050	5000 PSI	300° F	12 GPM	3/8" FPT	1/4" FPT	100	.20 lb

- Extends the life of your hose.
- Double PTFE slide rings for easy movement.
- Axial and radial slide bearing.
- Bearing material: PTFE.
- RPM: 30.



## ST-320 ELBOW SWIVELS *(stainless steel)*

ORDER #	PRESSURE	TEMP.	FLOW RATE	SIZE
200320510	5800 PSI	212° F	12 GPM	3/8" FPT x 3/8" MPT
200320555	5800 PSI	212° F	12 GPM	1/4" FPT x 1/4" MPT
	<b>BAG QTY.</b>	<b>WEIGHT</b>		
	10	.40 lb		

- RPM: 30



## ST-321 90° ELBOW SWIVEL *(brass & stainless steel)*

For car wash booms and hose reels.

ORDER #	PRESSURE	TEMP.	FLOW RATE	SIZE
200321510	5000 PSI	212° F	10 GPM	3/8" FPT x 1/2" FPT
	<b>BAG QTY.</b>	<b>WEIGHT</b>		
	10	.40 lb		

- RPM: 30



# SWIVELS



## ST-322 ELBOW SWIVELS (high flow)

High Flow stainless steel elbow swivel for use in hose reels or rotating booms.

ORDER #	PRESSURE	SIZE	WEIGHT
200322550	5800 PSI	3/8" MPT x 3/8" FPT	.90 lb
200322555	4500 PSI	3/8" MPT x 1/2" FPT	.92 lb
200322560	4500 PSI	1/2" MPT x 1/2" FPT	.94 lb
TEMP.	FLOW RATE	BOX QTY.	
212° F	26 GPM	10	

- High end sealing package.
- Stainless steel.
- RPM: 30.



## ST-340 SWIVELS (high flow)

1/2" live swivel is perfect for connecting to trigger, booms, etc.

ORDER #	PRESSURE	TEMP.	FLOW RATE	INLET	OUTLET
200340515	3200 PSI	212° F	42 GPM	1/2" MPT	1/2" FPT
200340025	3200 PSI	212° F	42 GPM	1/2" MPT	1/2" FPT
BOX QTY.	WEIGHT				
30	.25 lb				

Repair Kit: #200340100

- Stainless steel and brass versions.
- Double PTFE slide rings for easy movement.
- Bearing material: PTFE.
- RPM: 30.

#562391625



#562391615

## EASYWASH SWIVELS

Swivels applicable to high pressure spray guns and hose connections, ceiling booms as well as self-serve car wash.

ORDER #	PRESSURE	TEMP.	SIZE	BOX QTY.	WEIGHT
562391600	4000 PSI	250° F	1/4" MPT x 1/4" FPT	25	.30 lb
562391605	4000 PSI	250° F	1/4" MPT x 3/8" FPT	25	.30 lb
562391610	4000 PSI	250° F	3/8" MPT x 1/4" FPT	25	.30 lb
562391615	4000 PSI	250° F	3/8" MPT x 3/8" FPT	25	.35 lb
562391620	4000 PSI	250° F	1/4" FPT x 1/4" FPT	25	.40 lb
562391625	4000 PSI	250° F	3/8" FPT x 3/8" FPT	25	.40 lb
562391630	4000 PSI	250° F	1/4" FPT x M18 MPT	25	.40 lb

- Maintenance free.
- Nickel plated, stainless steel internal.

## ST-40 SCREW COUPLINGS (brass/plated steel)

Used anywhere high pressure connections are frequently connected and disconnected. Exchanging different lance, hose and spray gun versions are simple and easy just by hand tightening.

	ORDER #	PRESSURE	TEMP.	YORK /I.D.	INLET	OUTLET	WEIGHT
<b>A</b>	200040800	5800 PSI	300° F	M14	1/4" FPT	M22	.24 lb
<b>B</b>	200040810	5800 PSI	300° F	M14	1/4" MPT	M22	.22 lb
<b>C</b>	200040820	5800 PSI	300° F	M14	3/8" FPT	M22	.22 lb
<b>D</b>	200040830	5800 PSI	300° F	M14	3/8" MPT	M22	.20 lb
<b>E</b>	200040840	5800 PSI	300° F	M14	1/2" FPT	M22	.24 lb
<b>F</b>	200040850	5800 PSI	300° F	M14	1/2" MPT	M22	.22 lb
<b>G</b>	200040310	5800 PSI	300° F	M15	3/8" FPT	M22	.22 lb
<b>H</b>	<b>050000120 Replacement O-ring</b>						

- These couplers allow connection of male or female M22 (European-style) fittings 1/4", 3/8 and 1/2" pipe threads as shown.
- Available in M14 and M15 york.
- O-ring: Viton.

**Comparable rated components must be used together**



Front View  
Outlet: M22

## ST-40 SCREW COUPLINGS (stainless steel)

7250 PSI screw couplings, ideal for connections that have to be changed. Multiple versions to meet all of the connections applications.

	ORDER #	PRESSURE	TEMP.	YORK /I.D.	INLET	OUTLET	WEIGHT
<b>A</b>	200040900	7250 PSI	300° F	M14	1/4" FPT	M22	.24 lb
<b>B</b>	200040910	7250 PSI	300° F	M14	1/4" MPT	M22	.22 lb
<b>C</b>	200040930	7250 PSI	300° F	M14	3/8" MPT	M22	.22 lb
<b>D</b>	200040940	7250 PSI	300° F	M14	3/8" FPT	M22	.20 lb

O-ring: #050000120

- Allow connection of male and female M22 fitting and 1/4" and 3/8" pipe thread applications.
- Stainless steel construction for chemical and food applications.

**Comparable rated components must be used together**

**7250 PSI**

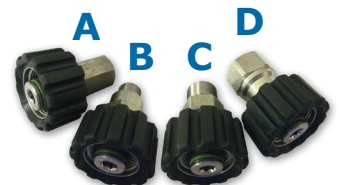

**FOOD GRADE**

# SCREW NIPPLES

## ST-41 SCREW NIPPLES (brass)

5800 PSI screw nipples, ideal for connections that have to be changed. Multiple versions to meet all of the connections applications.

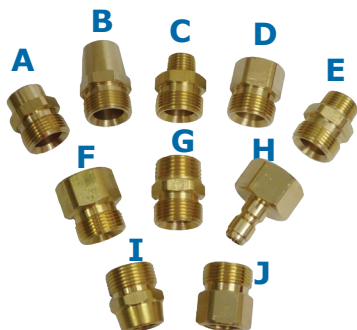

	ORDER #	YORK/I.D.	INLET	WEIGHT
A	010000561	M14	1/4" FPT	.12 lb
B	080056525	M14	1/4" FPT	.14 lb
C	010000562	M14	1/4" MPT	.10 lb
D	010000563	M14	3/8" FPT	.10 lb
E	010000564	M14	3/8" MPT	.10 lb
F	010000565	M14	1/2" FPT	.12 lb
G	010000566	M14	1/2" MPT	.12 lb
H	010000567	—	1/4" QC Plug	.10 lb
I	010002110	M15	1/4" FPT	.10 lb
J	010002120	M15	3/8" FPT	.10 lb

PRESSURE	TEMP.	OUTLET	BAG QTY
5800 PSI	300° F	M22	10

- Allow connection of male and female 1/4", 3/8" & 1/2" pipe thread applications.

**Comparable rated components must be used together**

## ST-41 SCREW NIPPLES (stainless steel)

7250 PSI screw nipples, ideal for connections that have to be changed. Multiple versions to meet all of the connections applications.

**7250 PSI**



**FOOD GRADE**

	ORDER #	PRESSURE	YOKE/I.D.	INLET	OUTLET	WEIGHT
A	040002300	7250 PSI	M14	1/4" FPT	M22	.12 lb
B	040002210	7250 PSI	M14	1/4" MPT	M22	.14 lb
C	040002200	7250 PSI	M14	3/8" FPT	M22	.10 lb
D	040002190	7250 PSI	M14	3/8" MPT	M22	.10 lb

TEMP.	BAG QTY
300° F	10

- Allow connection of male and female 1/4" and 3/8" pipe thread applications.
- Stainless steel construction for chemical and food applications.

**Comparable rated components must be used together**

## ST-44 SWIVEL SCREW COUPLINGS (ball bearing)

Exchanging different lance, hose and spray gun versions are simple and easy just by hand tightening.

#200044520



#200044500

ORDER #	PRESSURE	TEMP.	YOKE /I.D.	INLET	OUTLET	BAG QTY	WEIGHT
200044500	5800 PSI	300° F	M14	1/4" MPT	M22	100	.30 lb
200044520	5800 PSI	300° F	M14	3/8" FPT	M22	100	.40 lb

Seal Kit: # 5680011

- Combination of screw coupling and swivel.
- Live ball bearing swivel.
- Axial ball and radial slide bearing.

**Comparable rated components must be used together**

## ST-740 SCREW NIPPLES (stainless steel)

Ideal for connections that have to be changed. Multiple versions to meet all of the connections applications.

ORDER #	PRESSURE	TEMP.	YOKE/I.D.	SIZE	WEIGHT
200740501	10,150 PSI	300° F	M15	3/8" MBSP x M24	.35 lb
200740502	10,150 PSI	300° F	M15	3/8" FBSP x M24	.35 lb
200740503	10,150 PSI	300° F	M15	1/2" MBSP x M24	.35 lb
200740504	10,150 PSI	300° F	M15	1/4" MBSP x M24	.35 lb

O-ring: #050000408

Support ring: #050000407

- Allows connection of male and female M24 fittings and 1/4", 3/8" and 1/2" pipe thread applications.
- Stainless steel construction for chemical and food applications.
- O-ring: HNBR.

## 10,150 PSI



## ST-741 SCREW NIPPLES (stainless steel)

Ideal for connections that have to be changed. Multiple versions to meet all of the connections applications.

ORDER #	PRESSURE	TEMP.	YOKE/I.D.	SIZE	WEIGHT
200741501	10,150 PSI	300° F	M15	3/8" MBSP x M24	.16 lb
200741502	10,150 PSI	300° F	M15	3/8" FBSP x M24	.16 lb
200741503	10,150 PSI	300° F	M15	1/2" MBSP x M24	.16 lb
200741504	10,150 PSI	300° F	M15	1/4" FBSP x M24	.16 lb

O-ring: #050001000

- Allows connection of male and female M24 fittings and 1/4", 3/8" and 1/2" pipe thread applications.
- Stainless steel construction for chemical and food applications.
- O-ring: EPDM.

## 10,150 PSI



# BREAK AWAY FITTINGS, ADAPTER BUSHING & BAYONETS



## **BREAK AWAY FITTINGS (brass)**

An inexpensive protector for your spray gun and lance. All brass fitting is specifically designed to break before damage can occur to your spray gun or lance.

ORDER #	PRESSURE	THREAD SIZE	BAG QTY.	WEIGHT
900000077	5800 PSI	1/4" MPT x 1/4" FPT	10	.10 lb
900000078	5800 PSI	3/8" MPT x 3/8" FPT	10	.10 lb

- Attaches to lance or gun while protecting both.
- 3 to 1 safety factor.
- All brass design.



## **ADAPTER BUSHINGS**

ORDER #	PRESSURE	THREAD	MATERIAL
010000570	5800 PSI	1/8" QC Plug x 1/8" MPT	Plated Steel
010000571	5800 PSI	1/4" MPT x 1/4" MPT	Brass
010000573	5800 PSI	1/8" QC Plug x 1/4" MPT	Brass
010000574	5800 PSI	1/4" FPT x 3/8" MPT	Brass
57559	5000 PSI	3/8" F x 1/2" M	Stainless
57549	5000 PSI	1/2" M x 1/4" F	Stainless
57060	5000 PSI	1/2" M x 1/4" M	Brass
57040	5000 PSI	1/4" M x 1/4" M	Brass
57049	4000 PSI	1/4" M x 1/4" M	Stainless

TEMP.	WEIGHT
300° F	.08 lb



## **BAYONET ADAPTER 1/4" F(K)**

ORDER #	PRESSURE	TEMP.	DESCRIPTION	WEIGHT
200000440	2320 PSI	140° F	1/4" F Bayonet x 1/4" F Brass	.20 lb

- Easily allows the user to convert accessories on other manufacturers machines or equipment.



## **BAYONET PLUG 1/4" F(K)**

ORDER #	PRESSURE	TEMP.	DESCRIPTION	WEIGHT
200000436	2320 PSI	140° F	1/4" M Bayonet x 1/4" F Brass	.10 lb

Connection for hobby half lances.



Shown with connection and adapter together.

## **ST-61 METERING VALVE** (precision chemical mixture)

Allows for precision chemical mixture ratio. Connects to the chemical inlet hose barb of the ST-60, ST-62, ST-64 & ST-261 without special tools.

ORDER #	TEMP.	FLOW RATE	WEIGHT
999061500	300° F	.27 GPM	.60 lb

- Draw Rate: 0 - 11%.
- Connects to chemical inlet barb without any special tools needed.
- Made of glass filled poly-material, extremely corrosive resistant.
- Hose barb: 1/4".



Shown here with ST-60 Injector, products sold separately

## **ST-66 Dual METERING VALVE** (dual precision metering)

Chemical flow can be metered and shut off remotely from the injector.

ORDER #	TEMP.	FLOW RATE	WEIGHT
200066500	140° F	.27 GPM	.16 lb

- Draw Rate: 0 - 10%.
- Simply turn the knob to the desired side and setting.
- on the easy to read legend plate.
- Industry standard for panel mount chemical metering valves.



reverse side

## **ST-230 SAFETY RELIEF VALVES**

(stainless steel ball and valve seat)

Ideal in-line regulator for multi-gun pumping units on self-serve car wash systems. Perfect for pressure washer/steam combination applications and carpet cleaning industry.

ORDER #	PRESSURE	TEMP.	FLOW RATE	INLET	OUTLET
200230501	500-3600 PSI	200° F	8 GPM	1/4" FPT	1/4" FPT
200230601	500-5070 PSI	200° F	8 GPM	1/4" FPT	1/4" FPT
200230520	500-2200 PSI	200° F	8 GPM	1/4" FPT	1/4" FPT

O-RING	WEIGHT
EPDM	.84 lb

Repair Kit: #200230496

- Adjustable pressure.
- Forged brass housing.
- Special seals for maximum heat and chemical resistance.
- Can be rebuilt without removing from the installation.
- Valve member rides on elastomeric cushion, eliminating metal to metal contact, a common cause of regulator failure.



#200230501

# VALVES



## ST-264 BSP CHECK VALVES

Can be used in horizontal and vertical positions.

ORDER #	PRESSURE	INLET	OUTLET	MATERIAL	WEIGHT
200264600	5800 PSI	1/4" F	1/4" F	Stainless	.25 lb
200264610	2170 PSI	1/4" F	1/4" F	Brass	.30 lb
200264620	5800 PSI	3/8" F	3/8" F	Stainless	.27 lb
200264630	2170 PSI	3/8" F	3/8" F	Brass	.32 lb
200264640	5800 PSI	1/2" F	1/2" F	Stainless	.35 lb

- Opening pressure is 2 PSI.
- Viton o-rings.
- Temperature: 248° F.

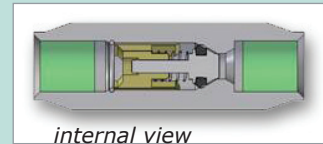

## PRESSURE RELIEF VALVE (brass)

Protects pressure washers against extreme pressure build-up.  
"Pop-off" protection.

ORDER #	PRESSURE	TEMP.	FLOW RATE	INLET	WEIGHT
900000069	1000-4000 PSI	180° F	6 GPM	3/8" MPT	.16 lb

- End discharge.
- Soft seat to eliminate weeping.
- Adjustable in the field.



## THERMAL RELIEF VALVE (stainless steel spring)

Protects pump from overheating while protecting packing and valves from excessive heat

ORDER #	PRESSURE	TEMP.	INLET	O-RING	WEIGHT
900000063	200 PSI	140° F	3/8" MPT	Nitrile	.14 lb

- Brass body, cap and actuator.
- Automatic reset.



## EASY START VALVE (brass)

Delays pressure increase by pump start.

ORDER #	PRESSURE	TEMP.	INLET	OUTLET	WEIGHT
200232560	5000 PSI	176° F	3/8" MBSP	1/4" MBSP	.15 lb

- Stainless steel seat, spring and ball.
- Makes "pull start" machines easier to start.
- Closes at 1 & 1/2 gallons per minute.

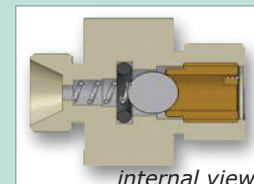

## ST-31 & ST-31R CHEMICAL STRAINERS (chemical resistant)

Soap enters through strainer preventing debris from entering the pump. A durable alternative to lightweight soap strainers.

ORDER #	MODEL	HOSE BARB	WEIGHT
200031600	ST-31	1/4" - 1/8"	.04 lb
200031610	ST-31R with check valve	1/4" - 1/8"	.04 lb

- Step down hose barb will attach to either a 1/4" or 1/8" hose.
- Internal brass weight keeps soap strainer in the bottom of the soap container.
- ST-31R has built in stainless steel and viton check valve to prevent water flow back into the soap solution.
- 4 ft clear hose available, #900000041.



#200031600

## ST-32 CHEMICAL STRAINERS (heavy weight)

Soap enters through strainer preventing debris from entering the pump. A durable alternative to lightweight strainers.

ORDER #	HOSE BARB	MATERIAL	WEIGHT
200032800	1/4"	Brass	.06 lb
200032600	5/16" or 3/8"	Stainless Steel	.06 lb

- Chemical resistant plastic screen out performs
- stainless steel screens
- Straight through design
- 4 ft clear hose available, #900000041



#200032600  
stainless steel

#200032800  
brass

## ST-33 INLET WATER STRAINERS (keeps pump debris free)

Inlet filter replaces the garden hose small filter screen and prevents debris from entering the pump

ORDER #	TEMP.	DESCRIPTION	WEIGHT
200033535	140° F	with 1/4" FPT bypass ports	.16 lb
200033540	140° F	—	.16 lb

PRESSURE	INLET	OUTLET
145 PSI	1/2" FPT	1/2" MPT

- Chemical resistant housing.
- 80 mesh stainless screen.



## ST-35 & ST-35R SUCTION STRAINERS (high volume)

High volume suction strainer ideal for tank transfer or agricultural markets

ORDER #	MODEL	HOSE BARB	WEIGHT
200035500	ST-35	1/2" - 3/4"	.88 lb
200035510	ST-35R (blue) with check valve	1/2" - 3/4"	.88 lb
200035520	ST-35R (blue) with check valve	3/4" - 1"	.92 lb
200035530	ST-35	3/4" - 1"	.92 lb

- Impact resistant plastic housing.
- Stainless steel screen.
- Brass weight to hold in place.



ST-35

ST-35 R

# CHEMICAL INJECTORS

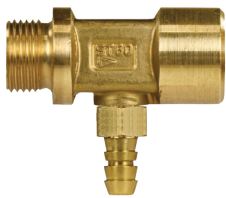

## ST-60 CHEMICAL INJECTORS (downstream)

The ST-60 is a downstream chemical injector that relies on a pressure drop that is created by using a larger orifice spray nozzle.

ORDER #	FLOW RATE	INJECTOR NOZZLE	ORIFICE
200060600	1.5 - 2.25 GPM	1.8 mm	5.5
200060610	2.5 - 3.35 GPM	2.1 mm	7.0
200060620	3.35 - 5.00 GPM	2.4 mm	10.0

PRESSURE	INLET	OUTLET
3600 PSI	3/8" MPT	3/8" FPT

Repair Kit: #200060720

- Siphon rate approximately 10:1.
- Forged brass housing, stainless steel spring and ball.
- 4 ft clear hose available, #900000041.
- Fixed flow rate for accuracy.
- 1/2" hose barb.
- Temperature rating of 140° F.



## ST-62 ADJUSTABLE CHEMICAL INJECTOR (downstream)

Allows for water flow adjustment from the pressure pump. By adjusting the water flow through the ST-62, a restriction causes a vacuum which allows the detergent to be drawn through the hose barb when a large orifice nozzle is used.

ORDER #	PRESSURE	INLET	OUTLET	HOSE BARB	WEIGHT
200062500	3600 PSI	3/8" FPT	3/8" FPT	1/4"	.20 lb

Repair Kit: #200060720

- Siphon rate approximately 10:1.
- Forged brass housing, stainless steel spring and ball.
- Adjusts to 8 GPM.
- Adjustable orifice size.
- 4 ft clear hose available, #900000041.

## ST-64 UPSTREAM CHEMICAL INJECTORS

(high pressure soap application)

Designed to introduce detergents into the water system upstream from the pump at a high pressure.

ORDER #	FLOW RATE	INLET	OUTLET	WEIGHT
999000019	1.5 - 4.0 GPM	3/4" F Garden	3/4" M Garden	.78 lb
999000021	4.0 - 7.0 GPM	3/4" F Garden	3/4" M Garden	.78 lb
999000022	1.5 - 4.0 GPM	1/2" FPT	1/2" MPT	.80 lb
999000023	4.0 - 7.0 GPM	1/2" FPT	1/2" MPT	.80 lb

Repair Kit: #200060720

- Includes hose and strainer.
- Adjustable chemical flow.
- Garden hose connection.
- Pressure: 140 PSI.
- Temperature rating of 140° F.
- 1/4" hose barb.
- 4 ft clear hose available, #900000041.



See in action!

[www.youtube.com/watch?v=npxhx9Ex30g](http://www.youtube.com/watch?v=npxhx9Ex30g)



## **ST-8 FLOAT VALVE (adjustable float)**

Used to regulate the maximum water level in a float tank.  
When the maximum water level drops the float valve opens.

ORDER #	PRESSURE	TEMP.	FLOW RATE	INLET	WEIGHT
200008520	140 PSI	176° F	5 GPM	1/2"	.44 lb

- Valve housing and connection are corrosion resistant material, brass and plastics.

### **ALSO AVAILABLE:**

**Repair Kit:**  
#200008495



**1/2" Adapter:**  
#200008526



**Replacement Ball:**  
#030000180



## **ST-10 & ST-11 FLOAT TANK/LID**

Complete float tank & lid used in regulating a constant flow of water to the pressure washer.

ORDER #	WEIGHT
999000780	1.38 lb

- 100% polypropylene.
- Mount ST-8 float valve anywhere needed.



## **ST-10 FLOAT TANK**

ORDER #	HOLD CAPACITY	DIMENSIONS	WEIGHT
020000780	1.8 gallons	13 3/4" L x 5 1/2" W x 6 3/4" H	1.12 lb



## **ST-11 FLOAT TANK LID**

ORDER #	WEIGHT
020000800	.26 lb



# ROTATING BRUSHES



#200020020  
Natural Bristles



#200020050  
Nylon Bristles

## ST-20 ROTATING BRUSHES

Rotating bristles for more effective cleaning. Ideal for car wash applications.

ORDER #	PRESSURE	TEMP.	FLOW RATE	ORIFICE
200020020	725 PSI	122° F	8 GPM	2.8
200020050	725 PSI	122° F	8 GPM	2.8
INLET	BRISTLES	WEIGHT		
1/4" MPT	Natural	1.68 lb		
1/4" MPT	Nylon	1.68 lb		

**Replacement Bristles:** Natural #020000910  
Nylon #020000870

- Natural horse hair or nylon bristles are available.
- Comes with a 2.8MM nozzle.
- 7 inch diameter.



#200021021  
Natural Bristles



#200021121  
Nylon Bristles

## ST-21 ADJUSTABLE ROTATING BRUSHES

Rotating bristles for more effective cleaning. Can be adjusted by as much as 180° making it perfect for both vertical and horizontal surfaces. Ideal for car wash applications.

ORDER #	PRESSURE	TEMP.	FLOW RATE	ORIFICE
200021021	725 PSI	122° F	8 GPM	2.8
200021121	725 PSI	122° F	8 GPM	2.8
INLET	BRISTLES	WEIGHT		
1/4" FPT	Natural	1.68 lb		
1/4" FPT	Nylon	1.68 lb		

**Replacement bristles:** Natural #020000910  
Nylon #020000870

- Natural horse hair or nylon bristles are available.
- Comes with a 2.8MM nozzle.
- Knuckle allows angle adjustment of brush.
- 7 inch diameter.

## ST-36 SLUDGE PUMP (high output)

Attaches to pressure washer and turns it into a high output pump.  
Great for flood cleanup, car wash pits, draining pools or chemical spills.

ORDER # 15 ft	ORDER # 25 ft	INLET	ORIFICE
999QC1530	—	1/4" M Q.C.	3.0 (0°)
999QC1540	999QC2540	1/4" M Q.C.	4.0 (0°)
999QC1545	999QC2545	1/4" M Q.C.	4.5 (0°)
999QC1550	999QC2550	1/4" M Q.C.	5.0 (0°)
999QC1555	999QC2555	1/4" M Q.C.	5.5 (0°)
999QC1560	999QC2560	1/4" M Q.C.	6.0 (0°)
999QC1570	—	1/4" M Q.C.	7.0 (0°)
999QC1580	—	1/4" M Q.C.	8.0 (0°)
999001540	999002540	M22	4.0 (0°)
999001545	999002545	M22	4.5 (0°)
999001550	999002550	M22	5.0 (0°)
999001555	999002555	M22	5.5 (0°)
999001560	999002560	M22	6.0 (0°)

PRESSURE	FLOW RATE	TEMP.
4000 PSI	11:1	104° F

- Vacuums up liquids and sludge at a high ratio.
  - \*Approximate ratio of 11:1 based on clean water. Ratio will vary depending on pressure, flow and viscosity.
- Water flowing through the high pressure nozzle creates a powerful venturi suction that vacuums up slurry solutions.
- Great for flood clean up, car wash pits, emptying pools or chemical pits.
- Debris as large as 3/4" will pass through the casting and out the discharge hose.
- Cleans up solutions/mixtures without pump damage.
- Acts like a sump or trash pump.
- Hose barb 1 1/2".
- Weight of hose is 8-10 lbs (depending on hose length).



M22 Screw Nipple



1/4" Q.C. Plug



Casting assembly w/ hose barb  
#200036500  
(without nipple and nozzle)



<https://www.youtube.com/watch?v=tXsMN9TzVI&feature=youtu.be>

# SANDBLASTING KITS

## ST-55 SANDBLASTING KIT

Designed for sandblasting a variety of surfaces and capable of removing most coatings down to white metal. Graffiti clean up, paint surface preparation, etc.



ORDER #	PRESSURE	TEMP.	DISCHARGE NOZZLE	ORIFICE	WEIGHT
200055509	3600 PSI	194° F	Steel	4.0	4.92 lb
200055504	3600 PSI	194° F	Steel	5.0	4.92 lb
200055500	3600 PSI	194° F	Steel	6.0	4.92 lb
200055507	3600 PSI	194° F	Steel	7.0	4.92 lb
200055508	3600 PSI	194° F	Steel	8.0	4.92 lb
200055491	3600 PSI	194° F	None	4.0	4.52 lb
200055494	3600 PSI	194° F	None	5.0	4.52 lb
200055492	3600 PSI	194° F	None	6.0	4.52 lb
200055497	3600 PSI	194° F	None	7.0	4.52 lb
200055493	3600 PSI	194° F	None	8.0	4.52 lb

- Works on venturi principle.
- Adjustable sand volume valve.
- Available with steel sand nozzle
- Use silica sand for best results.
- 13 ft hose.

## ST-555 SANDBLASTER



ORDER #	PRESSURE	TEMP.	DISCHARGE NOZZLE	ORIFICE	WEIGHT
200555530	7250 PSI	212° F	Steel	3.0	4.60 lb
200555540	7250 PSI	212° F	Steel	4.0	4.60 lb
200555555	7250 PSI	212° F	Steel	5.5	4.60 lb
200555565	7250 PSI	212° F	Steel	6.5	4.60 lb
200555575	7250 PSI	212° F	Steel	7.5	4.60 lb

- Professional grade.
- Stainless steel with adjustable sand flow.
- Thres times hardened stainless steel UHP-nozzles.
- Suitable for dust free blasting when using grain size ranging.
- from 0.2 mm - 1.5 mm.
- Multiple mediums can be used:
  - Glass Beads
  - Glass Powder
  - Slag (fine)
  - Slag (coarse)
  - Sodium Carbonate (water soluble)
  - Sand

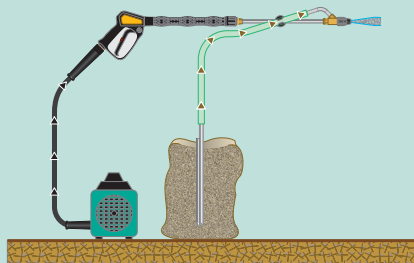

See in action!

[https://youtu.be/6l5vjknkOU0?si=vOY7NV6MnUn\\_8TUz](https://youtu.be/6l5vjknkOU0?si=vOY7NV6MnUn_8TUz)

# ADJUSTABLE BOOM & DISPLAY RACK

## ADJUSTABLE BOOM

The unique design allows you to shorten or extend boom to fit the size of car wash bays, lengthen for longer reach.

ORDER #	PRESSURE	TEMP.	INLET	OUTLET	LENGTH	WEIGHT
109765425	3000 PSI	250° F	3/8" FPT	3/8" MPT	42 - 78 in	20 lb

- Eliminates the need to stock multiple sizes.
- Stainless steel.
- Swivels are sealed and lubricated for long life.
- Ready for installation.
- 360° rotation.

Replacement swivel:  
#400320500



## ALSO AVAILABLE:

Wall Mount Bracket: #109721047

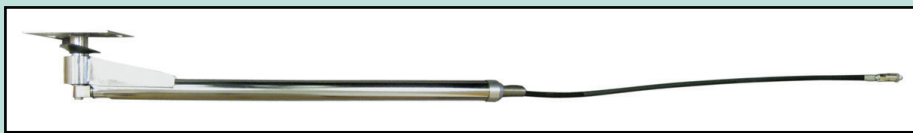

See in action!

[https://www.youtube.com/watch?v=\\_KljzAjvMDo](https://www.youtube.com/watch?v=_KljzAjvMDo)

## COUNTER TOP PRESSURE WASHER PARTS DISPLAY

Comes fully assembled and stocked with (2) of each of our most popular components purchased by pressure washer operators. You're ready to sell as soon as you remove the display from the shipping box and place it on your showroom counter top to display immediately.

ORDER #	DESCRIPTION
(P/N) 999S13000	Complete Counter Top Parts Display
(P/N) 200045702	1/4" MPT Socket
(P/N) 200045712	1/4" FPT Socket
(P/N) 200045722	3/8" MPT Socket
(P/N) 200045732	3/8" FPT Socket
(P/N) 200040800	1/4" F Coupling
(P/N) 200040820	3/8" F Coupling
(P/N) 100000142	1/4" M Q.C. Plug
(P/N) 100000152	1/4" F Q.C. Plug
(P/N) 100000162	3/8" M Q.C. Plug
(P/N) 100000172	3/8" F Q.C. Plug
(P/N) 999544500	5 Pack QC Meg 4.5
(P/N) 999544000	5 Pack QC Meg 4.0
(P/N) 201500910	3/8" FPT Inlet x 1/4" FPT 5K PSI Spray Gun
(P/N) 010000561	1/4" FPT Nipple
(P/N) 010000563	3/8" FPT Nipple
(P/N) 010000564	3/8" MPT Nipple
(P/N) 400357545	Turbo Nozzle 3600 PSI 4.5

- Delivered fully assembled.
- Free standing easel legs or pegboard hooks all for immediate positioning.



# DISPLAY RACK

## Pre-priced & Non-priced racks available

- P = pre-price (#P999S26120)
- N = non-price (#N999S26120)



Clear clam shell to view part easier

## PRESSURE WASHER PARTS DISPLAY

This "silent salesperson" accessories display is ready to increase your ticket sales. Simply remove the display from the shipping box and it is ready to sell on your showroom floor.

ORDER# (P/N)	DESCRIPTION	QTY
999S26120	Complete Parts Display	
200040800	M22 F x 1/4" FPT Screw Coupling	2
200040810	M22 F x 1/4" MPT Screw Coupling	1
200040820	M22 F x 3/8" FPT Screw Coupling	2
200040830	M22 F x 3/8" MPT Screw Coupling	1
010000561	M22 M x 1/4" FPT Nipple	1
010000562	M22 M x 1/4" MPT Nipple	2
010000563	M22 M x 3/8" FPT Nipple	1
010000564	M22 M x 3/8" MPT Nipple	2
200045702	Quick Coupler 1/4" M Socket	1
200045712	Quick Coupler 1/4" F Socket	2
200045722	Quick Coupler 3/8" M Socket	1
200045732	Quick Coupler 3/8" F Socket	2
100000142	Quick Connect 1/4" M Plug	1
100000152	Quick Connect 1/4" F Plug	1
100000162	Quick Connect 3/8" M Plug	2
100000172	Quick Connect 3/8" F Plug	2
900004045	0° x 4.5 Quick Nozzle RED	1
900001545	15° X 4.5 Quick Nozzle YELLOW	1
900002545	25° x 4.5 Quick Nozzle GREEN	1
900004045	40° x 4.5 Quick Nozzle WHITE	1
839006540	65° x 40.0 Quick Nozzle BLACK	1
999504500	0°, 15°, 25°, 40° x 4.5 Nozzle & Soap	1
200330500	F x F Adjustable Nozzle Holder	1
200301025	3/8" M x 3/8" F Swivel	1
999000060	Assorted O-rings	1
700000001	1/2" x 260" PTFE Thread Tape	1
200060600	3/8" M x 3/8" F Injector 1.8 orifice	1
200415505	1 /4" F 1750 PSI Turbo Nozzle	1
201500910	1/4" F 5000 PSI Spray Gun	1
200059935	Multi-Reg Nozzle	1
400357545	3000 PSI 4.5 Turbo Nozzle	1
900000009	1 /4" QC x 1 /4" M Turbo Filter	1
999000019	3/4" F x 3/4" M Soap Injector	1
700000100	12 oz Bag of Detergent	1
070000470	36" Molded Grip Lance	2
080032008	1/4" x 25' 3000 PSI Hose	1

- Stocked with 45 items most commonly purchased by pressure washer operators.
- Delivered fully assembled.
- Free standing easel legs or pegboard hooks all for immediate positioning.

# SANITIZING & DISINFECTING PRODUCTS

## STAINLESS STEEL FOGGING NOZZLE (ST-78)

ORDER #	TEMP.	INLET	MATERIAL
200078830	302° F	1/4" F	Stainless Steel

- Use for disinfection, humidification, cooling, dust suppression, decontamination, odor control in agricultural, food and construction industry, firefighting technology, car washing and detailing.

### ALSO AVAILABLE:

Longcast Stainless Steel Nozzle  
**SOLD SEPARATELY**



ORDER #	NOZZLE SIZE (MM)	ORIFICE SIZE
200078412	1.2 mm	3.5
200078415	1.5 mm	5.5
200078418	1.8 mm	8.0
200078420	2.0 mm	9.5
200078423	2.3 mm	10.0
200078425	2.5 mm	15.0
200078430	3.0 mm	25.0
200078435	3.5 mm	30.0
200078440	4.0 mm	40.0
200078445	4.5 mm	55.0
200078450	5.0 mm	60.0
200078470	7.0 mm	85.0

\*Nozzle needs to be sized to customer's machine.

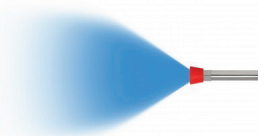

## SANTIZING & DISINFECTING COLD AIR FOGGER (ST-83)

- Easily sanitize and disinfect interiors to remove viruses and bacteria.
- Stainless steel components.
- Compressed air connection is required.
- Perfect tool for cleaning in hotels, public and agricultural areas, vehicles and so much more!
- The mist easily gets in the smallest areas and cracks.

Two different fog nozzle inserts are included.  
Easy change of nozzles by hand screw connection.



**Better swirling:**  
Particularly suitable in smaller rooms.



**Larger throw range:**  
For the treatment of entire rooms or for targeted treatment at the air intake of ventilation systems.



### ALSO AVAILABLE:

Window Attachment  
#200083400



#200083500



See in action!

<https://www.youtube.com/watch?v=d0WmJRosSjk&feature=youtu.be>

# ST-INDEX

ST-001 Lances.....	31	ST-2000 Spray Gun.....	14	ST-5 Flow Switches .....	118
ST-002 Molded Grip Lances.....	32	ST-2012 Spray Gun.....	15	ST-51N Adjustable Nozzle .....	59
ST-003 Lances.....	31	ST-2300 Weep Spray Gun .....	26	ST-51.1 Variable Spray Nozzles...29 & 59	
ST-004 Nozzle Protectors.....	51	ST-2305 Spray Gun.....	15	ST-52 Pressure Regulator.....	60
ST-007 Molded Grip Lances .....	32	ST-2305 Kew Coupler Spray Gun.....	16	ST-53 Dual Lances.....	35
ST-009 Lance Handles .....	44	ST-2315 Spray Gun.....	16	ST-53.2 Dual Lance .....	35
ST-009L Vented Grip Lances.....	34	ST-2320 Spray Gun.....	17	ST-54 Dual Lances.....	36
ST-10 Nozzle Protectors.....	51	ST-2605 Spray Gun.....	17	ST-54.2 Dual Lance .....	36
ST-10 Float Tank.....	139	ST-2605F Spray Gun .....	17	ST-55 Sandblasting Kit .....	142
ST-11 Float Tank Lid .....	139	ST-2620 Spray Gun.....	18	ST-56 Roll-Over Nozzle .....	60
ST-11 Nozzle Protector.....	51	ST-2620F Spray Gun .....	18	ST-58 Change-Over Valve.....	60
ST-129 Molded Grip Lances .....	33	ST-2620F Spray Gun w/ Lance.....	18	ST-505 Flow Switch .....	119
ST-154 Dual Lances.....	37	ST-2635 Industrial Spray Gun.....	19	ST-510 Soft Wash Spray Gun .....	24
ST-160 Chemical Injector.....	94	ST-2700 Spray Gun.....	19	ST-550 Foot Actuated Valve .....	90
ST-160M Chemical Injector.....	95	ST-2715 Spray Gun.....	19	ST-555 Sandblaster.....	142
ST-160.2 Chemical Injector.....	97	ST-2720 Spray Gun.....	20	ST-559 Turbo Nozzle .....	55
ST-160.3 Chemical Injector.....	98	ST-2720F Spray Gun .....	20	ST-6 Flow Switch .....	118
ST-160.3A Chemical Injector.....	99	ST-2750 Spray Gun.....	20	ST-60 Chemical Injectors.....	138
ST-161 Metering Valve.....	116	ST-31 & ST-31R Chemical Strainers..	137	ST-61 Metering Valve .....	135
ST-161 Stop Nut .....	116	ST-32 Chemical Strainer.....	116 & 137	ST-61 Metering Valve .....	135
ST-164 Chemical Bypass Injector.....	100	ST-33 Inlet Water Strainers .....	137	ST-62 Adjustable Chemical Injector....	138
ST-164A Chemical Bypass Injector....	101	ST-35 & ST-35R Suction Strainers....	137	ST-64 Upstream Chem. Injectors .....	138
ST-166 Dual Chemical Injector.....	102	ST-36 Sludge Pump.....	141	ST-66 Dual Metering Valve .....	135
ST-166M Dual Chemical Injector.....	103	ST-301 Swivel Couplings .....	128	ST-601 Spray Gun .....	22
ST-167 Chemical Bypass Injector.....	104	ST-303 Swivel .....	128	ST-601C Spray Gun .....	22
ST-167M Chemical Bypass Injector....	105	ST-310 Swivel Couplings .....	129	ST-601 Weep Spray Gun .....	25
ST-168 Chemical Bypass Injector.....	106	ST-311 Swivel Coupling.....	129	ST-7 Flow Switches .....	119
ST-168M Chemical Bypass Injector....	107	ST-320 Elbow Swivels.....	129	ST-7.1 Pressure Switch .....	119
ST-175 Foam Lance.....	112	ST-321 90° Elbow Swivels.....	129	ST-72 Foam Lance .....	114
ST-176 Foam Lance.....	113	ST-322 Elbow Swivels.....	130	ST-72F Foam Lance .....	114
ST-1100 Spray Gun.....	13	ST-330 Adjustable Nozzle Holders .....	59	ST-73 Foamer .....	109
ST-1100 Weep Spray Gun.....	25	ST-340 Swivels.....	130	ST-73H Foamer .....	109
ST-1200B Wash Down Spray Gun.....	24	ST-357 Turbo Nozzle.....	53	ST-75 Foam Nozzle .....	110
ST-1200S Wash Down Gun.....	24	ST-357 Twin Turbo Nozzle Lances.....	38	ST-75 Replacement Screen & Pad .....	115
ST-1500 Spray Gun.....	13	ST-3100 Coupling & Plugs.....	115	ST-75S Foam Nozzle .....	110
ST-1500C Spray Gun.....	13	ST-3225 Inline Spray Gun.....	22	ST-75.2 Long Range Foam Nozzle .....	111
ST-1500H Spray Gun.....	13	ST-3240 Hydro-Ex Spray Gun.....	23	ST-75.3 Foam Head .....	24
ST-1500 Stainless Steel Spray Gun....	14	ST-3300 Spray Gun.....	21	ST-76 Foam Blaster.....	111
ST-1500 Weep Spray Gun.....	26	ST-3500 Spray Gun.....	21	ST-78 Fogging Nozzle .....	145
ST-1700 Spray Gun .....	14	ST-3600 Lances.....	40	ST-740 Screw Couplings.....	133
ST-2 Lance Insulator.....	44	ST-3600 Spray Gun.....	21	ST-741 Screw Nipples .....	133
ST-20 Rotating Brushes.....	140	ST-40 Screw Couplings .....	131	ST-8 Float Valve .....	139
ST-21 Adjustable Rotating Brushes...140		ST-41 Screw Nipples.....	132	ST-83 Fogger .....	145
ST-29 Molded Grip Lances.....	33	ST-44 Swivel Screw Couplings.....	132	ST-85 Push/Pull Lances .....	40
ST-230 Safety Relief Valve.....	135	ST-49 Rotating Sewer Nozzles....69 & 70		ST-810 Spray Gun .....	12
ST-261 Unloader Valve.....	120	ST-415 Turbo Nozzle .....	55	ST-810 P.O.M. Spray Gun .....	12
ST-261C Unloader Valve.....	120	ST-456 Turbo Nozzle .....	53	ST-810 Weep Spray Gun .....	25
ST-261T Unloader Valve.....	120	ST-456 Twin Turbo Nozzle Lances.....	38	ST-860D Steam Gun .....	27
ST-261I Unloader Valves.....	121	ST-457 Turbo Nozzle.....	54	ST-9 & ST-9H Vented Lance Grips .....	44
ST-261S Unloader Valve.....	121	ST-457H Turbo Nozzle.....	56	ST-96 Swivel.....	128
ST-261SI Unloader Valves .....	121	ST-457 Twin Turbo Nozzle Lances.....	39		
ST-264 High Pressure Check Valves..136		ST-458 Turbo Nozzle.....	54		
ST-265 Unloader Valves .....	122	ST-458 Turbo Nozzle.....	57		
ST-275 Unloader Valves .....	122	ST-458H Turbo Nozzle.....	57		
ST-280 Unloader Valve.....	122	ST-4000 Steam Gun.....	27		
ST-280.2 Unloader Valve.....	122				
ST-285 Unloader Valves .....	123				
ST-291 Unloader Valve.....	123				
ST-291S Unloader Valve.....	123				

# NOZZLE CHART

Nozzle Orifice Size	Pounds Per Square Inch (PSI)															Gallons Per Minute (GPM)																																																																																																																																																																																																																																																																																																																																																																																																																																																																													
	500 PSI	600 PSI	700 PSI	800 PSI	1000 PSI	1500 PSI	2000 PSI	2500 PSI	3000 PSI	3500 PSI	4000 PSI	4500 PSI	5000 PSI	5500 PSI	6000 PSI	6500 PSI	7000 PSI	7500 PSI	8000 PSI	500 GPM	600 GPM	700 GPM	800 GPM	1000 GPM	1500 GPM	2000 GPM	2500 GPM	3000 GPM	3500 GPM	4000 GPM	4500 GPM	5000 GPM	5500 GPM	6000 GPM	6500 GPM	7000 GPM	7500 GPM	8000 GPM																																																																																																																																																																																																																																																																																																																																																																																																																																																							
2	.71	.77	.84	.89	1.0	1.2	1.4	1.6	1.7	1.9	2.0	2.1	2.2	2.3	2.4	2.5	2.6	2.7	2.8	2.9	3.0	3.1	3.2	3.3	3.4	3.5	3.6	3.7	3.8	3.9	4.0	4.1	4.2	4.3	4.4	4.5	4.6	4.7	4.8	4.9	5.0	5.1	5.2	5.3	5.4	5.5	5.6	5.7	5.8	5.9	6.0	6.1	6.2	6.3	6.4	6.5	6.6	6.7	6.8	6.9	7.0	7.1	7.2	7.3	7.4	7.5	7.6	7.7	7.8	7.9	8.0	8.1	8.2	8.3	8.4	8.5	8.6	8.7	8.8	8.9	9.0	9.1	9.2	9.3	9.4	9.5	9.6	9.7	9.8	9.9	10.0																																																																																																																																																																																																																																																																																																																																																																																																		
2.5	.9	1.0	1.0	1.1	1.3	1.6	1.8	2.0	2.2	2.3	2.5	2.7	2.8	2.9	3.1	3.2	3.3	3.4	3.5	3.6	3.7	3.8	3.9	4.0	4.1	4.2	4.3	4.4	4.5	4.6	4.7	4.8	4.9	5.0	5.1	5.2	5.3	5.4	5.5	5.6	5.7	5.8	5.9	6.0	6.1	6.2	6.3	6.4	6.5	6.6	6.7	6.8	6.9	7.0	7.1	7.2	7.3	7.4	7.5	7.6	7.7	7.8	7.9	8.0	8.1	8.2	8.3	8.4	8.5	8.6	8.7	8.8	8.9	9.0	9.1	9.2	9.3	9.4	9.5	9.6	9.7	9.8	9.9	10.0																																																																																																																																																																																																																																																																																																																																																																																																									
3.0	1.1	1.2	1.3	1.4	1.5	1.8	2.1	2.4	2.6	2.8	3.0	3.2	3.4	3.5	3.7	3.8	3.9	4.0	4.1	4.2	4.3	4.4	4.5	4.6	4.7	4.8	4.9	5.0	5.1	5.2	5.3	5.4	5.5	5.6	5.7	5.8	5.9	6.0	6.1	6.2	6.3	6.4	6.5	6.6	6.7	6.8	6.9	7.0	7.1	7.2	7.3	7.4	7.5	7.6	7.7	7.8	7.9	8.0	8.1	8.2	8.3	8.4	8.5	8.6	8.7	8.8	8.9	9.0	9.1	9.2	9.3	9.4	9.5	9.6	9.7	9.8	9.9	10.0																																																																																																																																																																																																																																																																																																																																																																																																															
3.5	1.3	1.4	1.5	1.6	1.8	2.2	2.5	2.8	3.1	3.3	3.5	3.7	3.9	4.1	4.3	4.5	4.6	4.7	4.8	4.9	5.0	5.1	5.2	5.3	5.4	5.5	5.6	5.7	5.8	5.9	6.0	6.1	6.2	6.3	6.4	6.5	6.6	6.7	6.8	6.9	7.0	7.1	7.2	7.3	7.4	7.5	7.6	7.7	7.8	7.9	8.0	8.1	8.2	8.3	8.4	8.5	8.6	8.7	8.8	8.9	9.0	9.1	9.2	9.3	9.4	9.5	9.6	9.7	9.8	9.9	10.0																																																																																																																																																																																																																																																																																																																																																																																																																						
4.0	1.4	1.6	1.7	1.8	2.0	2.5	2.8	3.2	3.5	3.7	4.0	4.2	4.5	4.7	4.9	5.1	5.2	5.3	5.4	5.5	5.6	5.7	5.8	5.9	6.0	6.1	6.2	6.3	6.4	6.5	6.6	6.7	6.8	6.9	7.0	7.1	7.2	7.3	7.4	7.5	7.6	7.7	7.8	7.9	8.0	8.1	8.2	8.3	8.4	8.5	8.6	8.7	8.8	8.9	9.0	9.1	9.2	9.3	9.4	9.5	9.6	9.7	9.8	9.9	10.0																																																																																																																																																																																																																																																																																																																																																																																																																												
4.5	1.6	1.7	1.9	2.0	2.3	2.8	3.2	3.6	3.9	4.2	4.5	4.8	5.0	5.3	5.5	5.7	5.8	5.9	6.0	6.1	6.2	6.3	6.4	6.5	6.6	6.7	6.8	6.9	7.0	7.1	7.2	7.3	7.4	7.5	7.6	7.7	7.8	7.9	8.0	8.1	8.2	8.3	8.4	8.5	8.6	8.7	8.8	8.9	9.0	9.1	9.2	9.3	9.4	9.5	9.6	9.7	9.8	9.9	10.0																																																																																																																																																																																																																																																																																																																																																																																																																																		
5.0	1.8	1.9	2.1	2.2	2.5	3.1	3.5	4.0	4.3	4.7	5.0	5.3	5.6	5.9	6.1	6.4	6.5	6.6	6.7	6.8	6.9	7.0	7.1	7.2	7.3	7.4	7.5	7.6	7.7	7.8	7.9	8.0	8.1	8.2	8.3	8.4	8.5	8.6	8.7	8.8	8.9	9.0	9.1	9.2	9.3	9.4	9.5	9.6	9.7	9.8	9.9	10.0																																																																																																																																																																																																																																																																																																																																																																																																																																									
5.5	1.9	2.1	2.3	2.5	2.8	3.4	3.9	4.3	4.8	5.1	5.5	5.8	6.2	6.4	6.7	7.0	7.3	7.4	7.5	7.6	7.7	7.8	7.9	8.0	8.1	8.2	8.3	8.4	8.5	8.6	8.7	8.8	8.9	9.0	9.1	9.2	9.3	9.4	9.5	9.6	9.7	9.8	9.9	10.0																																																																																																																																																																																																																																																																																																																																																																																																																																																	
6.0	2.1	2.3	2.5	2.7	3.0	3.7	4.2	4.7	5.2	5.6	6.0	6.4	6.7	7.0	7.3	7.6	7.9	8.2	8.5	8.8	9.1	9.4	9.7	10.0	10.3	10.6	10.9	11.2	11.5	11.8	12.1	12.4	12.7	13.0	13.3	13.6	13.9	14.2	14.5	14.8	15.1	15.4	15.7	16.0	16.3	16.6	16.9	17.2	17.5	17.8	18.1	18.4	18.7	19.0	19.3	19.6	19.9	20.2	20.5	20.8	21.1	21.4	21.7	22.0	22.3	22.6	22.9	23.2	23.5	23.8	24.1	24.4	24.7	25.0	25.3	25.6	25.9	26.2	26.5	26.8	27.1	27.4	27.7	28.0	28.3	28.6	28.9	29.2	29.5	29.8	30.1	30.4	30.7	31.0	31.3	31.6	31.9	32.2	32.5	32.8	33.1	33.4	33.7	34.0	34.3	34.6	34.9	35.2	35.5	35.8	36.1	36.4	36.7	37.0	37.3	37.6	37.9	38.2	38.5	38.8	39.1	39.4	39.7	40.0	40.3	40.6	40.9	41.2	41.5	41.8	42.1	42.4	42.7	43.0	43.3	43.6	43.9	44.2	44.5	44.8	45.1	45.4	45.7	46.0	46.3	46.6	46.9	47.2	47.5	47.8	48.1	48.4	48.7	49.0	49.3	49.6	49.9	50.2	50.5	50.8	51.1	51.4	51.7	52.0	52.3	52.6	52.9	53.2	53.5	53.8	54.1	54.4	54.7	55.0	55.3	55.6	55.9	56.2	56.5	56.8	57.1	57.4	57.7	58.0	58.3	58.6	58.9	59.2	59.5	59.8	60.1	60.4	60.7	61.0	61.3	61.6	61.9	62.2	62.5	62.8	63.1	63.4	63.7	64.0	64.3	64.6	64.9	65.2	65.5	65.8	66.1	66.4	66.7	67.0	67.3	67.6	67.9	68.2	68.5	68.8	69.1	69.4	69.7	70.0	70.3	70.6	70.9	71.2	71.5	71.8	72.1	72.4	72.7	73.0	73.3	73.6	73.9	74.2	74.5	74.8	75.1	75.4	75.7	76.0	76.3	76.6	76.9	77.2	77.5	77.8	78.1	78.4	78.7	79.0	79.3	79.6	79.9	80.2	80.5	80.8	81.1	81.4	81.7	82.0	82.3	82.6	82.9	83.2	83.5	83.8	84.1	84.4	84.7	85.0	85.3	85.6	85.9	86.2	86.5	86.8	87.1	87.4	87.7	88.0	88.3	88.6	88.9	89.2	89.5	89.8	90.1	90.4	90.7	91.0	91.3	91.6	91.9	92.2	92.5	92.8	93.1	93.4	93.7	94.0	94.3	94.6	94.9	95.2	95.5	95.8	96.1	96.4	96.7	97.0	97.3	97.6	97.9	98.2	98.5	98.8	99.1	99.4	99.7	100.0																																																																																																																																																									
6.5	2.3	2.5	2.7	2.9	3.3	4.0	4.6	5.1	5.6	6.1	6.5	6.9	7.3	7.6	8.0	8.3	8.6	8.9	9.2	9.5	9.8	10.1	10.4	10.7	11.0	11.3	11.6	11.9	12.2	12.5	12.8	13.1	13.4	13.7	14.0	14.3	14.6	14.9	15.2	15.5	15.8	16.1	16.4	16.7	17.0	17.3	17.6	17.9	18.2	18.5	18.8	19.1	19.4	19.7	20.0	20.3	20.6	20.9	21.2	21.5	21.8	22.1	22.4	22.7	23.0	23.3	23.6	23.9	24.2	24.5	24.8	25.1	25.4	25.7	26.0	26.3	26.6	26.9	27.2	27.5	27.8	28.1	28.4	28.7	29.0	29.3	29.6	29.9	30.2	30.5	30.8	31.1	31.4	31.7	32.0	32.3	32.6	32.9	33.2	33.5	33.8	34.1	34.4	34.7	35.0	35.3	35.6	35.9	36.2	36.5	36.8	37.1	37.4	37.7	38.0	38.3	38.6	38.9	39.2	39.5	39.8	40.1	40.4	40.7	41.0	41.3	41.6	41.9	42.2	42.5	42.8	43.1	43.4	43.7	44.0	44.3	44.6	44.9	45.2	45.5	45.8	46.1	46.4	46.7	47.0	47.3	47.6	47.9	48.2	48.5	48.8	49.1	49.4	49.7	50.0	50.3	50.6	50.9	51.2	51.5	51.8	52.1	52.4	52.7	53.0	53.3	53.6	53.9	54.2	54.5	54.8	55.1	55.4	55.7	56.0	56.3	56.6	56.9	57.2	57.5	57.8	58.1	58.4	58.7	59.0	59.3	59.6	59.9	60.2	60.5	60.8	61.1	61.4	61.7	62.0	62.3	62.6	62.9	63.2	63.5	63.8	64.1	64.4	64.7	65.0	65.3	65.6	65.9	66.2	66.5	66.8	67.1	67.4	67.7	68.0	68.3	68.6	68.9	69.2	69.5	69.8	70.1	70.4	70.7	71.0	71.3	71.6	71.9	72.2	72.5	72.8	73.1	73.4	73.7	74.0	74.3	74.6	74.9	75.2	75.5	75.8	76.1	76.4	76.7	77.0	77.3	77.6	77.9	78.2	78.5	78.8	79.1	79.4	79.7	80.0	80.3	80.6	80.9	81.2	81.5	81.8	82.1	82.4	82.7	83.0	83.3	83.6	83.9	84.2	84.5	84.8	85.1	85.4	85.7	86.0	86.3	86.6	86.9	87.2	87.5	87.8	88.1	88.4	88.7	89.0	89.3	89.6	89.9	90.2	90.5	90.8	91.1	91.4	91.7	92.0	92.3	92.6	92.9	93.2	93.5	93.8	94.1	94.4	94.7	95.0	95.3	95.6	95.9	96.2	96.5	96.8	97.1	97.4	97.7	98.0	98.3	98.6	98.9	99.2	99.5	99.8	100.1	100.4	100.7	101.0	101.3	101.6	101.9	102.2	102.5	102.8	103.1	103.4	103.7	104.0	104.3	104.6	104.9	105.2	105.5	105.8	106.1	106.4	106.7	107.0	107.3	107.6	107.9	108.2	108.5	108.8	109.1	109.4	109.7	110.0	110.3	110.6	110.9	111.2	111.5	111.8	112.1	112.4	112.7	113.0	113.3	113.6	113.9	114.2	114.5	114.8	115.1	115.4	115.7	116.0	116.3	116.6	116.9	117.2	117.5	117.8	118.1	118.4	118.7	119.0	119.3	119.6	119.9	120.2	120.5	120.8	121.1	121.4	121.7	122.0	122.3	122.6	122.9	123.2	123.5	123.8	124.1	124.4	124.7	125.0	125.3	125.6	125.9	126.2	126.5	126.8	127.1	127.4	127.7	128.0	128.3	128.6	128.9	129.2	129.5	129.8	130.1	130.4	130.7	131.0	131.3	131.6	131.9	132.2	132.5	132.8	133.1	133.4	133.7	134.0	134.3	134.6	134.9	135.2	135.5	135.8	136.1	136.4	136.7	137.0	137.3	137.6	137.9	138.2	138.5	138.8	139.1	139.4	139.7	140.0	140.3	140.6	140.9	141.2	141.5	141.8	142.1	142.4	142.7	143.0	143.3	143.6	143.9	144.2	144.5	144.8	145.1	145.4	145.7	146.0	146.3	146.6</

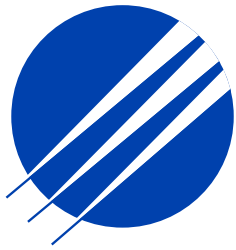

# SUTTNER

A M E R I C A C O M P A N Y

*PRESSURE WASHER COMPONENTS & ACCESSORIES*

---

With over **60** years of experience, Suttner America Company is one of the worldwide leading manufacturers of high quality products for the cleaning industry

**ADDRESS:**

14864 West Ridge Ln.  
Dubuque, IA 52003

**FAX:**

(563) 556.3038  
(800) 821.0660

**PHONE:**

(563) 556.3212  
(800) 831.0660

**EMAIL:**

[sales@suttner.com](mailto:sales@suttner.com)

**WEB:**

[www.suttner.com](http://www.suttner.com)

---

***GERMAN ENGINEERED TECHNOLOGY***